



**Technický a zkušební ústav  
stavební Praha, s.p.**

Prosecká 811/76a  
190 00 Prague  
Czech Republic  
tel.: +420 286 019 400  
W: www.tzus.cz



Member of



www.eota.eu

## European Technical Assessment

**ETA 20/1044**  
**of 26/11/2023**

General part

### Technical Assessment Body issuing the European Technical Assessment

Technický a zkušební ústav stavební Praha, s.p.

<b>Trade name of the construction product</b>	PS, PSL, PSS, PSO, PSP, PSPW, PSPD, PSPOD, PSP DX, PST, PSH, PSZ, PSW, PSD, PSC, PSOL, PSOZ, PUW, PMF, PSRL, PSRLT, PSRU, PS/500, PSSOZ, PSSZ, PS R500, PSW R500, PSS R500, PMFU
<b>Product family to which the construction product belongs</b>	Product area: 13 Three-dimensional Nailing Plates
<b>Manufacturer</b>	DOMAX Sp. z o.o. Aleja Parku Krajobrazowego 109 84-207 Koleczkowo Łężyce Republic of Poland
<b>Manufacturing plant</b>	DOMAX Sp. z o.o. Aleja Parku Krajobrazowego 109 84-207 Koleczkowo Łężyce Republic of Poland
<b>This European Technical Assessment contains</b>	94 pages including 6 Annexes, which form an integral part of this European Technical Assessment
<b>This European Technical Assessment is issued in accordance with Regulation (EU) No 305/2011, on the basis of</b>	EAD 130186-00-0603 Three-dimensional nailing plates
<b>This version replaces</b>	ETA 20/1044, version 01 issued on 24/03/2021

Translations of this European technical assessment in other languages shall fully correspond to the original issued document and should be identified as such.

Communication of this European Technical Assessment, including transmission by electronic means, shall be in full (excepted the confidential Annex(es) referred to above). However, partial reproduction may be made, with the written consent of the issuing Technical Assessment Body - Technický a zkušební ústav stavební Praha, s.p. Any partial reproduction has to be identified as such.

## 1 Technical description of the product

The three-dimensional nailing plates are one-piece or multi-piece, non-welded or welded (PS, PSS, PSL, PSP, PSPW, PSPD, PSPOD, PST, PSH, PSZ, PSW, PSD, PUW, PMF, PSRL, PSRLT, PS /500, PSSZ, PSRU /500, PSSOZ, PS R500, PSW R500, PSS R500, PSRU R500, PMFU) elements made of the cold-formed steel sheet grade DX51D according to EN 10346 or structural steel S235 according to EN 10025-2 with corrosion protection Fe/Zn 12, zinc coating mass of 275 g/m<sup>2</sup>, Hot-dip galvanization (HDG), cataphoretic coating (KTL) or powder coating 60 µm (see list below). The three-dimensional nailing plates correspond to the drawings and dimensions given in Annex 1.

**Table 1** Technical description of the product

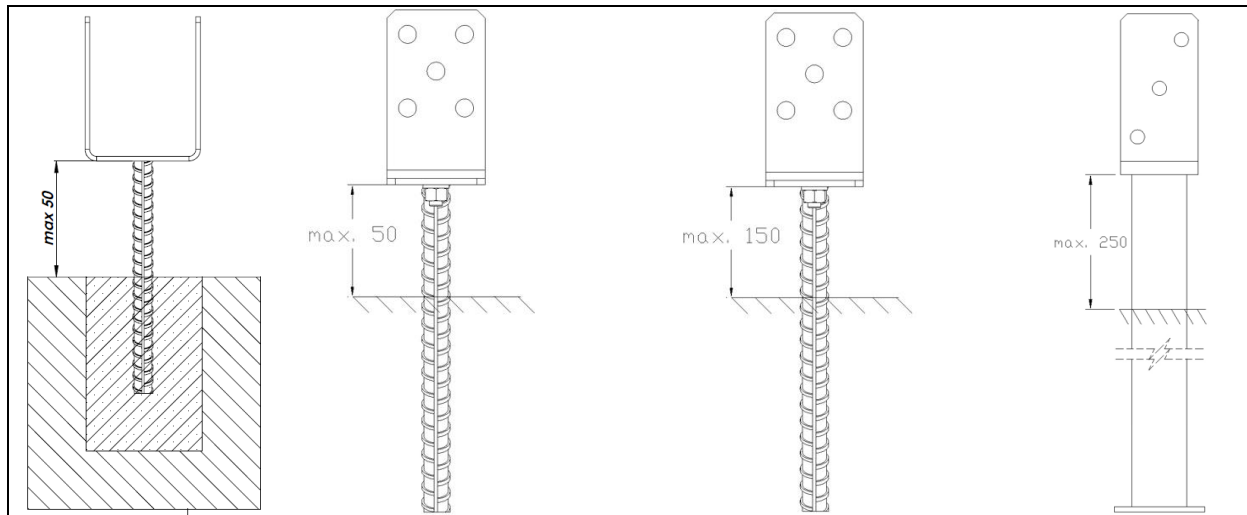
Type of Domax connector	Made of	Kind of corrosion protection	Type of connector		Intended use	
PS 75U	S235	Fe/Zn 12 or Z275 or Hot-dip galvanization (HDG) or Cataphoretic coating (KTL) or additional powder coating 60 µm	Embedded base	Post base	Three-dimensional nailing plate for use as connection in loadbearing timber structures (used to connect vertical timber columns to concrete, wood or steel ground)	End-grain to steel plate
PS 150U	S235		Embedded base			
PS 160U	S235		Embedded base			
PSL 45U	S235		Embedded base			
PSS 60	S235		Embedded base			
PSS 80	S235		Embedded base			
PSS 100	S235		Embedded base			
PSS 120	S235		Embedded base			
PSS 140	S235		Embedded base			
PSO 50	S235		Screwed base			
PSO 60	S235		Screwed base			
PSO 70	S235		Screwed base			
PSO 80	S235		Screwed base			
PSO 90	S235		Screwed base			
PSO 100	S235		Screwed base			
PSO 120	S235		Screwed base			
PSP 140	S235		Screwed base			
PSP 160	S235		Screwed base			
PSP 200	S235		Screwed base			
PSPW 70	S235		Screwed base			
PSPW 90	S235		Screwed base			
PSPW 100	S235		Screwed base			
PSPW 120	S235		Screwed base			
PSPW 140	S235		Screwed base			
PSPW 150	S235		Screwed base			
PSPW 160	S235		Screwed base			
PSPW 200	S235		Screwed base			
PSPD 70	S235		Screwed base			
PSPD 90	S235		Screwed base			
PSPD 100	S235		Screwed base			

Type of Domax connector	Made of	Kind of corrosion protection	Type of connector	Intended use
PSPD 120	S235		Screwed base	
PSPD 140	S235		Screwed base	
PSPD 150	S235		Screwed base	
PSPD 160	S235		Screwed base	
PSPD 200	S235		Screwed base	
PSPOD 80	S235		Screwed base	
PSPOD 90	S235		Screwed base	
PSPOD 100	S235		Screwed base	
PSPOD 120	S235		Screwed base	
PSP DX 45	DX51D		Screwed base	
PSP DX 70	DX51D		Screwed base	
PSP DX 90	DX51D		Screwed base	
PSP DX 100	DX51D		Screwed base	
PSP DX 120	DX51D		Screwed base	
PSP DX 140	DX51D		Screwed base	
PSP DX 150	DX51D		Screwed base	
PST 75	S235		Screwed base	
PST 80	S235		Screwed base	
PST 150	S235		Screwed base	
PST 160	S235		Screwed base	
PST 200	S235		Screwed base	
PSH 70	S235		Embedded base	
PSH 80	S235		Embedded base	
PSH 90	S235		Embedded base	
PSH 100	S235		Embedded base	
PSH 120	S235		Embedded base	
PSH 140	S235		Embedded base	
PSH 160	S235		Embedded base	
PSH 200	S235		Embedded base	
PSZ 60	S235		Embedded base	
PSZ 70	S235		Embedded base	
PSZ 90	S235		Embedded base	
PSZ 100	S235		Embedded base	
PSZ 120	S235		Embedded base	
PSZ 140	S235		Embedded base	
PSW 70	S235		Embedded base	
PSW 90	S235		Embedded base	
PSD 90	S235		Screwed base	
PSD 100	S235		Screwed base	
PSD 120	S235		Screwed base	
PSD 140	S235		Screwed base	
PSD 160	S235		Screwed base	
PSD 200	S235		Screwed base	

Type of Domax connector	Made of	Kind of corrosion protection	Type of connector	Intended use
PSC 45	S235		Screwed base	
PSC 60	S235		Screwed base	
PSC 75	S235		Screwed base	
PSC 90	S235		Screwed base	
PSOL 45	DX51D		Screwed base	
PSOL 50	DX51D		Screwed base	
PSOL 60	DX51D		Screwed base	
PSOL 70	DX51D		Screwed base	
PSOL 90	DX51D		Screwed base	
PSOL 100	DX51D		Screwed base	
PSOZ 60	S235		Screwed base	
PSOZ 70	S235		Screwed base	
PSOZ 90	S235		Screwed base	
PSOZ 100	S235		Screwed base	
PSOZ 120	S235		Screwed base	
PSOZ 140	S235		Screwed base	
PUW 90	S235		Screwed base	
PUW 100	S235		Screwed base	
PUW 120	S235		Screwed base	
PUW 140	S235		Screwed base	
PMF 80-100	S235		Screwed base	
PMF 80-150	S235		Screwed base	
PMF 80-200	S235		Screwed base	
PMF 100-100	S235		Screwed base	
PMF 100-150	S235		Screwed base	
PMF 100-200	S235		Screwed base	
PSRL 0-160	S235 B500B		Embedded base	
PSRL 0-160/400	S235 B500B		Embedded base	
PSRLT 0-160	S235 B500B		Screwed base	
PS 90U/500	S235 B500B		Embedded base	
PS 100U/500				
PS 120U/500				
PS 140U/500				
PS 160U/500				
PSSZ 60	S235 B500B	Embedded base		
PSSZ 80				
PSSZ 100				
PSSZ 120				
PSSZ 140				
PSSZ 160	S235 B500B	Embedded base		
PSRU 60-200/500				

Type of Domax connector	Made of	Kind of corrosion protection	Type of connector	Intended use
PSSOZ 60	S235		Screwed base	
PSSOZ 80				
PSSOZ 100				
PSSOZ 120				
PSSOZ 140				
PSSOZ 160				
PS 90U R500	S235		Embedded base	
PS 100U R500				
PS 120U R500				
PS 140U R500				
PS 160U R500				
PSW 70 R500	S235		Embedded base	
PSW 90 R500				
PSS 100 R500	S235		Embedded base	
PSS 120 R500				
PSS 140 R500				
PSS 160 R500				
PSRU 60-200 R500	S235		Embedded base	
PMFU 100	S235	Screwed base		
PMFU 120				
PMFU 140				
PMFU 160				

For post bases with threaded rods have to be fulfilled the maximal free length 50 mm or as mentioned in figure below. Threaded rods are made from rebars B500SP or ribbed bars HRB400E.



**Figure 1** Post base with threaded rod





















PSRL 0-160  
PSSZ 60-160























PSRL 0-160/400  
PSRU 60-200/500  
PS 90U-160U/500






















PS90U-160U R500  
PSW 70 R500,  
PSW 90 R500, PSS  
100-160 R500

For welded three-dimensional nailing plates the information about weld is mentioned in table below.






















**Table 2** Weld information


Name	Weld size [mm]	Symbol	Weld length [mm]	Qty.
PS 75U	3.5		64.3	1
PS 150U	3.5		64.3	1
PS 160U	3.5		64.3	1
PSS 60	3.5		50.3	1
PSS 80	3.5		50.3	1
PSS 100	3.5		50.3	1
PSS 120	3.5		50.3	1
PSS 140	3.5		50.3	1
PSP 140	3		60	4
PSP 160	3		80	4
PSP 200	3		100	4
PSPW 70	3		16	4
	3		40	2
PSPW 90	3		16	4
	3		40	2
PSPW 100	3		32	4
	3		50	2
PSPW 120	3		32	4
	3		60	2
PSPW 140	3		41	4




Name	Weld size [mm]	Symbol	Weld length [mm]	Qty.
	3		70	2
PSPW 150	3		41	4
	3		75	2
PSPW 160	3		51	4
	3		80	2
PSPW 200	3		66	4
	3		100	2
PSPD 70	3		20	4
	3		40	2
PSPD 90	3		20	4
	3		60	2
PSPD 100	3		35	4
	3		70	2
PSPD 120	3		35	4
	3		90	2
PSPD 140	3		40	4
	3		100	2
PSPD 150	3		50	4
	3		100	2
PSPD 160	3		50	4
	3		120	2
PSPD 200	3		65	4

Name	Weld size [mm]	Symbol	Weld length [mm]	Qty.
	3		160	2
PSPOD 80	3		45	2
PSPOD 90	3		55	2
PSPOD 100	3		65	2
PSPOD 120	3		75	2
PST 75	3		110	2
PST 150	3		110	2
PST 160	3		110	2
PST 200	3		110	2
PSH 70	3		60	4
PSH 90	3		60	4
PSH 100	3		60	4
PSH 120	3		60	4
PSH 140	3		60	4
PSZ 60	3.5		64.3	1
PSZ 70	3.5		64.3	1
PSZ 90	3.5		64.3	1
PSZ 100	3.5		64.3	1
PSZ 120	3.5		64.3	1
PSZ 140	3.5		64.3	1
PSW 70	3.5		50.3	1



Name	Weld size [mm]	Symbol	Weld lenght [mm]	Qty.
PSW 90	3.5		50.3	1
PSD 90	3		17	2
	3		70	1
PSD 100	3		32	2
	3		90	1
PSD 120	3		32	2
	3		100	1
PSD 140	3		41	2
	3		140	1
PSD 160	3		50	2
	3		140	1
PSD 200	3		66	2
	3		180	1
PUW 90	3		41	4
PUW 100	3		46.5	4
PUW 120	3		56.5	4
PUW 140	3		66.5	4
PMF 80-100	3		211.6	2
PMF 80-150	3		211.6	2
PMF 80-200	3		211.6	2
PMF 100-100	3		266.3	2

Name	Weld size [mm]	Symbol	Weld length [mm]	Qty.
PMF 100-150	3		266.3	2
PMF 100-200	3		266.3	2
PSL 45	3.5		50.3	1
PSRL 0-160	3.5		64.3	1
PSRL 0-160 400	3.5		70.65	1
PSRLT 0-160	3.5		64.3	2
PS 60U/500	3.5		80.1	1
PS 100U/500	3.5		80.1	1
PS 120U/500	3.5		80.1	1
PS 140U/500	3.5		80.1	1
PS 160U/500	3.5		80.1	1
PSSZ 60	3.5		64.3	1
PSSZ 80	3.5		64.3	1
PSSZ 100	3.5		64.3	1
PSSZ 120	3.5		64.3	1
PSSZ 140	3.5		64.3	1
PSSZ 160	3.5		64.3	1
PSRU 60- 200/500	3.5		80.1	1
PS 90U R500	3.5		144.2	2
PS 100U R500	3.5		144.2	2
PS 120U R500	3.5		144.2	2
PS 140U R500	3.5		144.2	2

Name	Weld size [mm]	Symbol	Weld length [mm]	Qty.
PS 160U R500	3.5		144.2	2
PSW 70 R500	3.5		144.2	2
PSW 90 R500	3.5		144.2	2
PSS 100 R500	3.5		144.2	2
PSS 120 R500	3.5		144.2	2
PSS 140 R500	3.5		144.2	2
PSS 160 R500	3.5		144.2	2
PSRU 60-200 R500	3.5		144.2	2
PMFU 100	3.5		144.2	2
PMFU 120	3.5		144.2	2
PMFU 140	3.5		144.2	2
PMFU 160	3.5		144.2	2

Yield strength for used steel DX51D is 300 MPa, tensile strength is 373 MPa (thickness 1.5 mm)  
Yield strength for used steel DX51D is 315 MPa, tensile strength is 389 MPa (thickness 2.0 mm).  
Yield strength for used steel S235JR is 334 MPa, tensile strength is 389 MPa (thickness 2.0 mm).  
Yield strength for used steel DX51D is 289 MPa, tensile strength is 363 MPa (thickness 2.5 mm).  
Yield strength for used steel S235JR is 365 MPa, tensile strength is 456 MPa (thickness 2.5 mm).  
Yield strength for used steel S235JR is 290 MPa, tensile strength is 381 MPa (thickness 3.0 mm).  
Yield strength for used steel S235JR is 245 MPa, tensile strength is 378 MPa (thickness 4.0 mm).  
Yield strength for used steel S235JR is 289 MPa, tensile strength is 407 MPa (thickness 5.0 mm).  
Yield strength for used steel S235JR is 328 MPa, tensile strength is 404 MPa (thickness 6.0 mm).  
Yield strength for used steel S235JR is 247 MPa, tensile strength is 363 MPa (thickness 8.0 mm).  
Tensile strength for used rebars B500SP is 671 MPa (diameter 18.0 mm)  
Yield strength for used ribbed bars HRB400E is 450 MPa, tensile strength is 630 MPa (diameter 20.0 mm).  
Yield strength for used ribbed bars HRB400E is 465 MPa, tensile strength is 625 MPa (diameter 22.0 mm).

## 1.1 Identification

The identification parameters and reference to product specifications for identifying the materials and components which constitute the three-dimensional nailing plates are given in Annex 1.

## **2 Specification of the intended use(s) in accordance with the applicable European Assessment Document (hereinafter EAD)**

The three-dimensional nailing plates are intended to be used as connections in loadbearing timber structures (to connect vertical timber columns to concrete, wood or steel ground). For connecting the mutually perpendicular, load-bearing, solid timber elements, in side-grain to side-grain configurations, in joints for which requirements for mechanical resistance and stability in the sense of the Basic Works Requirement 1 of Regulation (EU) No 305/2011 shall be fulfilled.

For connections made with the three-dimensional nailing plates shall be used the elements described in Annex 1.

In respect of the requirements concerning corrosion resistance, three-dimensional nailing plates are for use in timber structures subjected to the internal conditions defined by service classes 1, 2 and 3 (connectors with additional powder coating) according to EN 1995-1-1 (Eurocode 5), in corrosion aggressiveness categories C1 and C2 according to EN ISO 12944-2, without action of acid gases or vapours.

The provisions made in this European Technical Assessment are based on an assumed working life of the product of 50 years. The indications given on the working life cannot be interpreted as a guarantee given by the producer, but are to be regarded only as a means for choosing the right products in relation to the expected economically reasonable working life of the works.

The assessment of the fitness of the three-dimensional nailing plates for the intended use has been made in compliance with the European Assessment Document (EAD) 130186-00-0603 Three-dimensional nailing plates.

### **2.1 Installation of three-dimensional nailing plates**

The installation instructions including special installation techniques and provisions for the qualification of the personnel are given in the manufacturer's technical documentation.

## **3 Performance of the product and references to the methods used for its assessment**

The assessment of the fitness for use of the above-mentioned three-dimensional nailing plates according to the Basic Work Requirements (BWR) were carried out in compliance with EAD 130186-00-0603.

The European Technical Assessment is issued for the three-dimensional nailing plates on the basis of agreed data and information, deposited at Technický a zkušební ústav stavební Praha, s.p., which identifies three-dimensional nailing plates that has been assessed and judged. Changes to the plates or production process which could result in this deposited data and information being incorrect should be notified to Technický a zkušební ústav stavební Praha, s.p. before the changes are introduced. Technický a zkušební ústav stavební Praha, s.p. will decide whether or not such changes affect the ETA and consequently the validity of the CE marking on the basis of the ETA and if so whether further assessment or alternations to the ETA shall be necessary.

**Table 3** Essential characteristics of the product

	Essential characteristic	Performance
3.1	BWR 1: Mechanical resistance and stability	
3.1.1	Joint strength	See Annex 3
3.1.2	Joint stiffness	NPA
3.1.3	Joint ductility	NPA
3.1.4	Resistance to seismic actions	NPA
3.1.5	Resistance to corrosion and deterioration	NPA
3.2	BWR 2: Safety in case of fire	
3.2.1	Reaction to fire	The steel elements are classified as class A1 of reaction to fire (non-combustible products) in accordance with EN 13501-1+A1 and to European Commission Decision 96/603/EC amended by European Commission Decision 2000/605/EC.
3.2.2	Resistance to fire	NPA

### 3.1 Mechanical resistance and stability (BWR 1)

#### 3.1.1 Joint strength

The characteristic load-carrying capacities of joints loaded according to static diagrams (shown in Annex 2), determined by calculations carried out according to EAD 130186-00-0603, clause 2.2.1 and EN 1995-1-1 are given in Annex 3. The characteristic load-carrying capacities of joints for other load directions shall be calculated on the basis of EN 1995-1-1 (Eurocode 5) or according to national regulations. The design values shall be determined according to EN 1995-1-1 (Eurocode 5).

Following the requirements of EAD, the applicant provided to the TAB calculation results, configuration of the connections and static schemes (direction of force actions).

#### 3.1.2 Joint stiffness

No performance assessed.

#### 3.1.3 Joint ductility

No performance assessed.

### 3.2 Safety in case of fire (BWR 2)

#### 3.2.1 Reaction to fire

The steel elements are classified as class A1 of reaction to fire (non-combustible products) in accordance with EN 13501-1+A1 and to European Commission Decision 96/603/EC amended by European Commission Decision 2000/605/EC.

#### 3.2.2 Resistance to fire

Performance in relation to fire resistance would be determined for the complete structural element with any associated finishes, therefore there is no performance assessed option used to this Basic Work Requirement.

#### 4 Assessment and verification of constancy of performance (hereinafter AVCP) system applied, with reference to its legal base

According to the Decision 1997/638/EC<sup>1</sup>, of the European Commission the system(s) of assessment and verification of constancy of performance (see Annex V to Regulation (EU) No 305/2011 and Commission delegated Regulation (EU) No 568/2014) given in the following table applies:

Product(s)	Intended use(s)	Level(s) or class(es)	Attestation of conformity system(s)
<b>Shear plates, toothed-plate connectors, punched nail plates, nailing plates</b>	For structural timber products		2+

---

<sup>1</sup> Official Journal of the European Communities L 268/37 of 1.10.1997

## **5 Technical details necessary for the implementation of the AVCP system, as provided for in the applicable EAD**

Technical details necessary for the implementation of the AVCP system are laid down in the control plan deposited at Technický a zkušební ústav stavební Praha, s.p.

Issued in Prague on 26/11/2023

By  
Ing. Jiří Studnička, Ph.D.  
Head of the TAB

### Annexes:

- Annex 1 Product details and definitions
- Annex 2 Loading according to static diagrams
- Annex 3 The characteristic load-carrying capacities of connectors
- Annex 4 Nailing patterns
- Annex 5 Specification of connection elements
- Annex 6 Reference documents

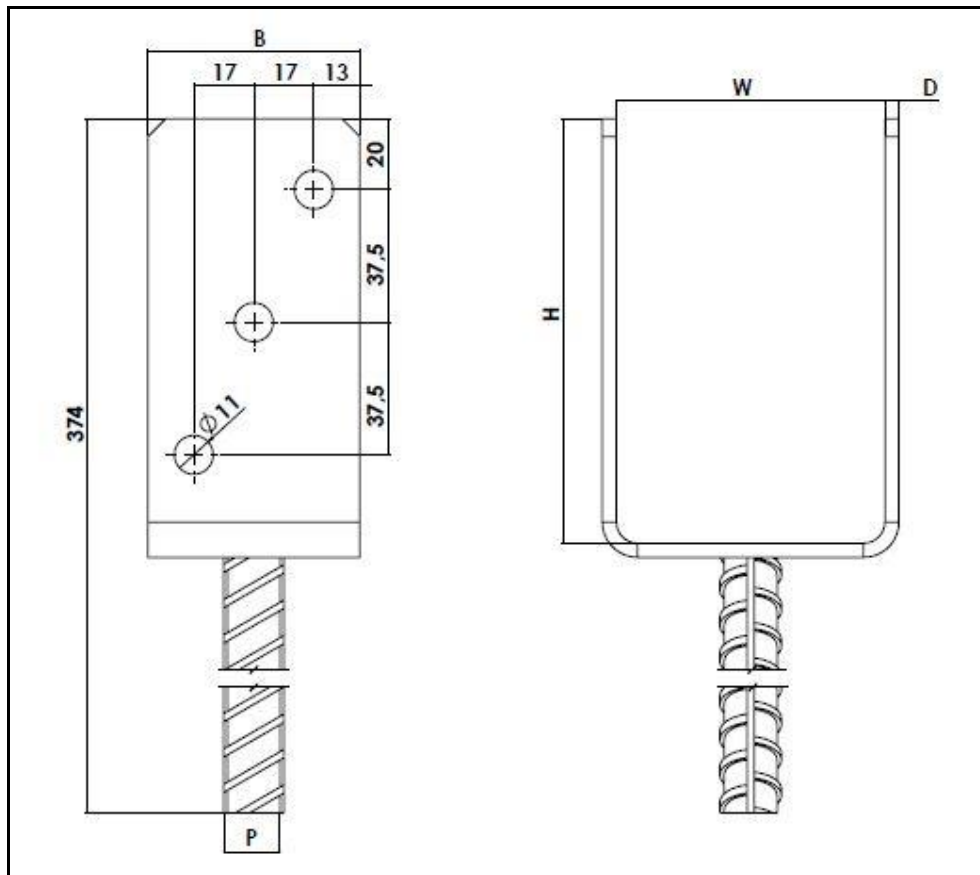
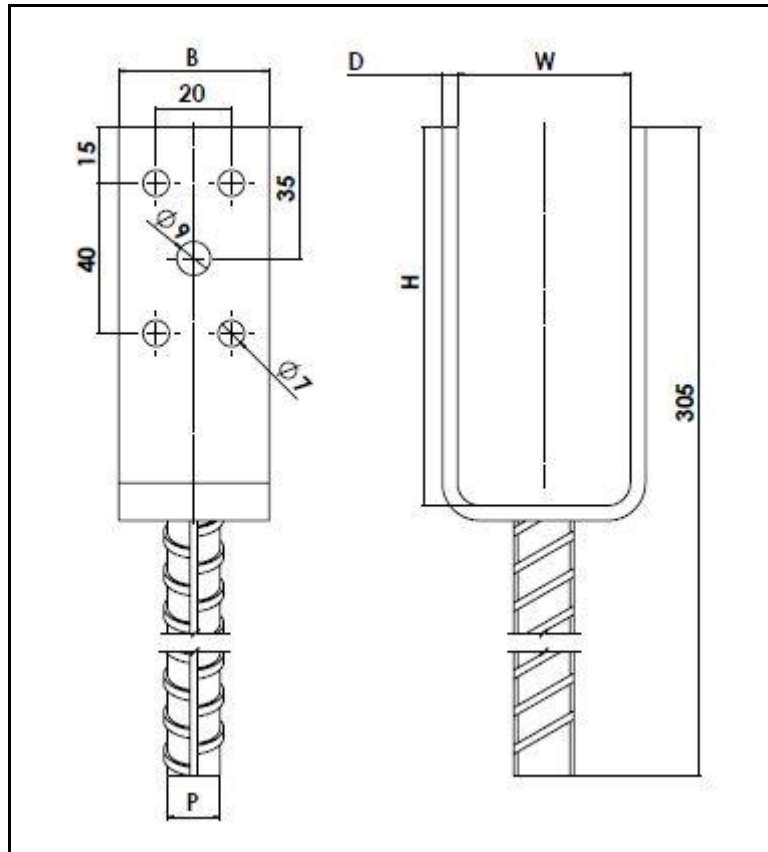


Figure 2 Type PS 75U

Table 4 PS three-dimensional nailing plate symbols and dimensions

Symbol	Dimensions, mm					Quantity of openings
	W	H	B	D	P	Ø11
PS 75U	76	120	60	4	18	6
PS 150U	152	120	60	4	18	6
PS 160U	162	120	60	4	18	6

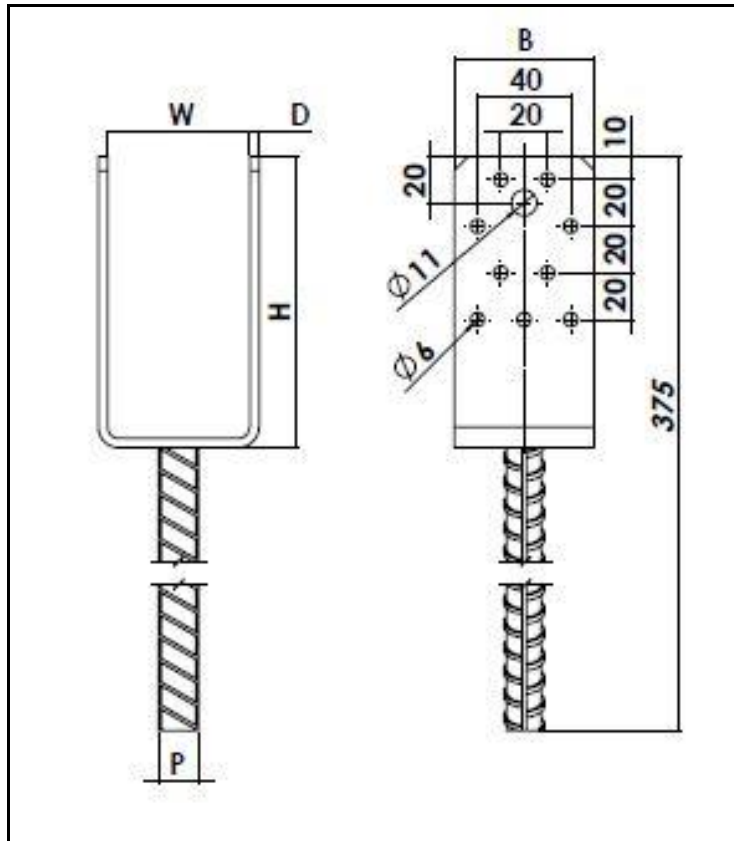




**Figure 3** Type PSL 45U

**Table 5** PSL three-dimensional nailing plate symbols and dimensions

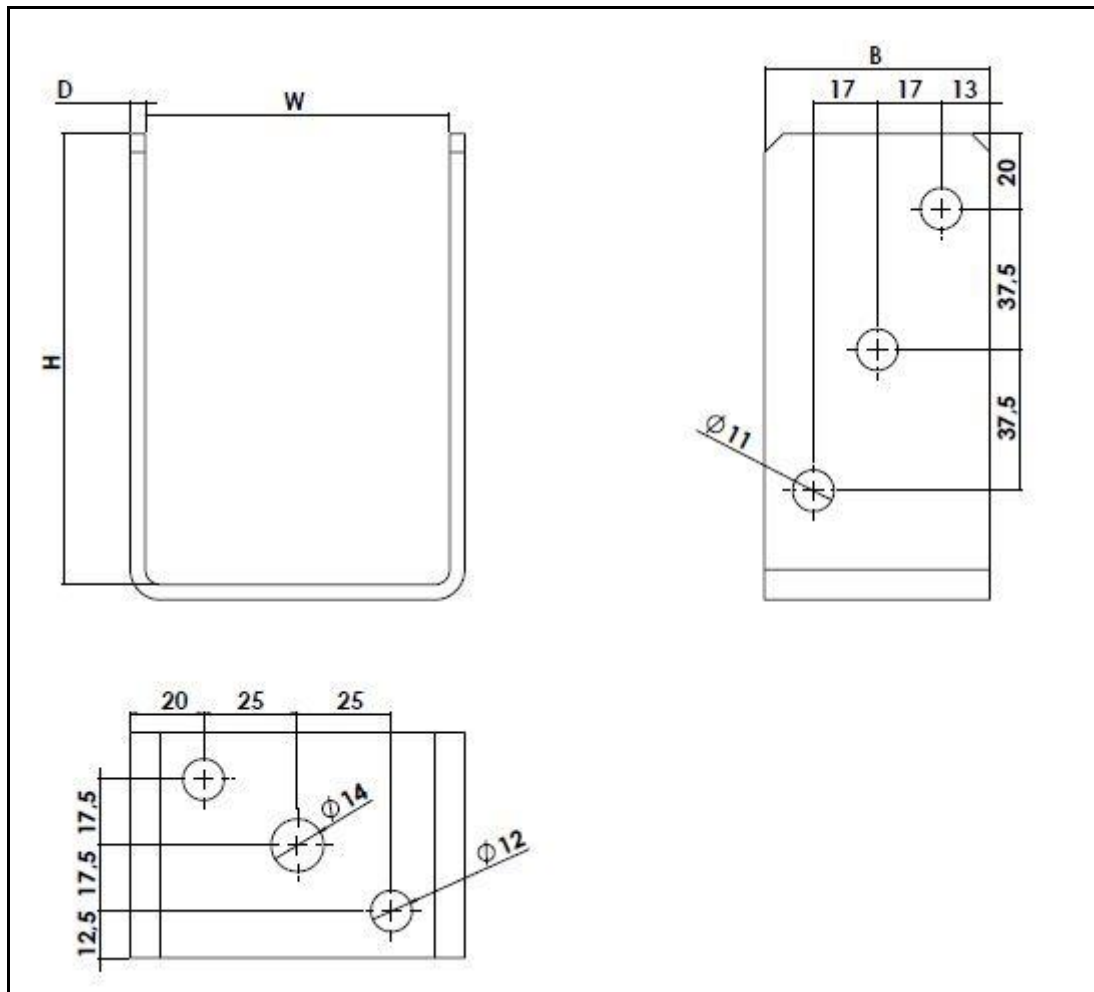
Symbol	Dimensions, mm					Quantity of openings	
	W	H	B	D	P	Ø7	Ø9
PSL 45U	46	101	40	4	16	8	2



**Figure 4** Type PSS 60

**Table 6** PSS three-dimensional nailing plate symbols and dimensions

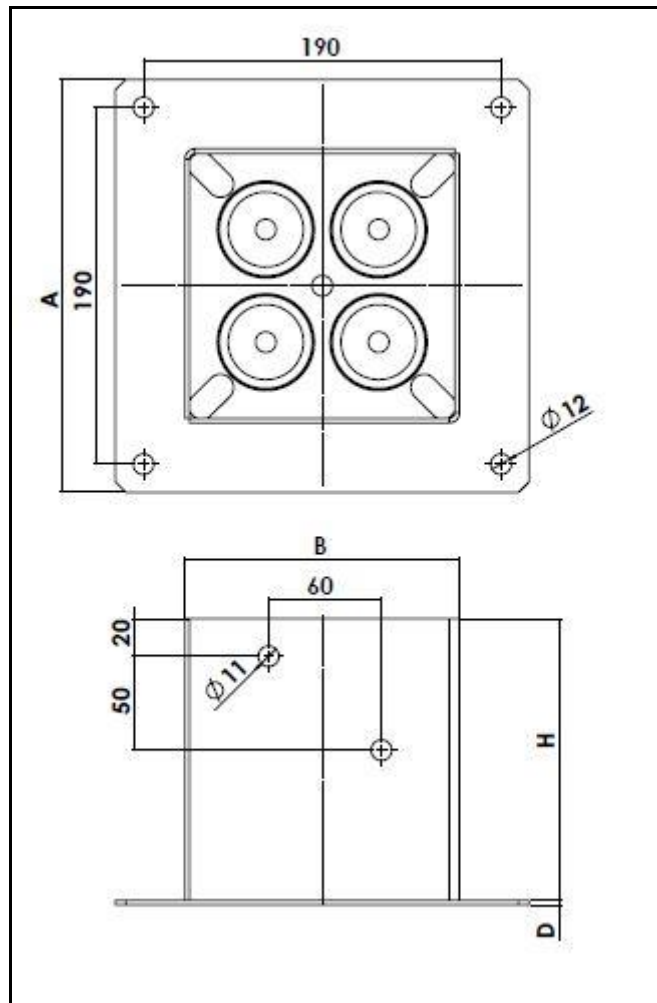
Symbol	Dimensions, mm					Quantity of openings	
	W	H	B	D	P	Ø6	Ø11
PSS 60	61	125	60	4	16	18	2
PSS 80	81	125	80	4	16	26	2
PSS 100	101	125	100	4	16	32	4
PSS 120	121	125	120	4	18	40	4
PSS 140	141	125	120	4	18	40	4



**Figure 5** Type PSO 80

**Table 7** PSO three-dimensional nailing plate symbols and dimensions

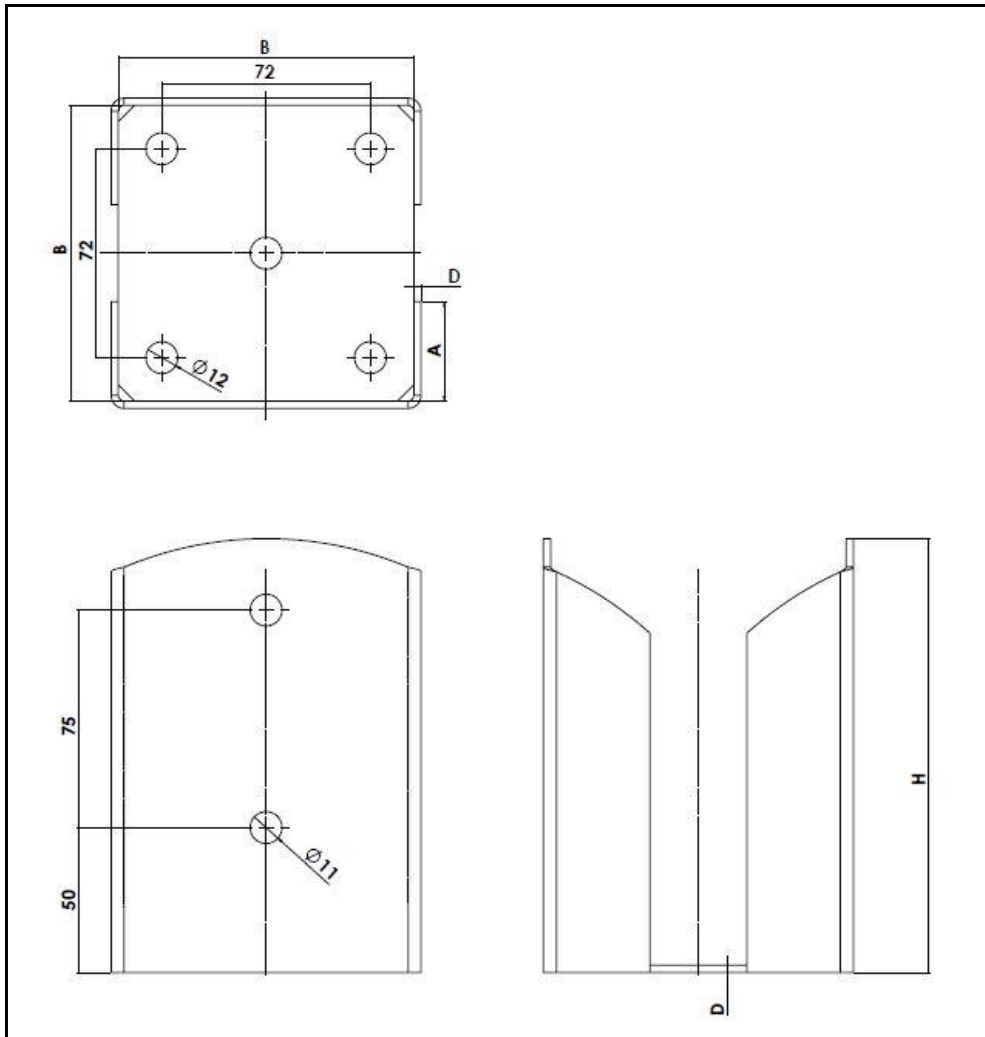
Symbol	Dimensions, mm				Quantity of openings				
	W	H	B	D	Ø7	Ø9	Ø11	Ø12	Ø14
PSO 50	52	101	40	4	8	4	-		-
PSO 60	62	101	40	4	8	4	-		-
PSO 70	71	120	60	4	-	-	6	2	-
PSO 80	81	120	60	4	-	-	6	2	1
PSO 90	91	120	60	4	-	-	6	2	1
PSO 100	101	120	60	4	-	-	6	2	1
PSO 120	121	120	60	4	-	-	6	2	1



**Figure 6** Type PSP 140

**Table 8** PSP three-dimensional nailing plate symbols and dimensions

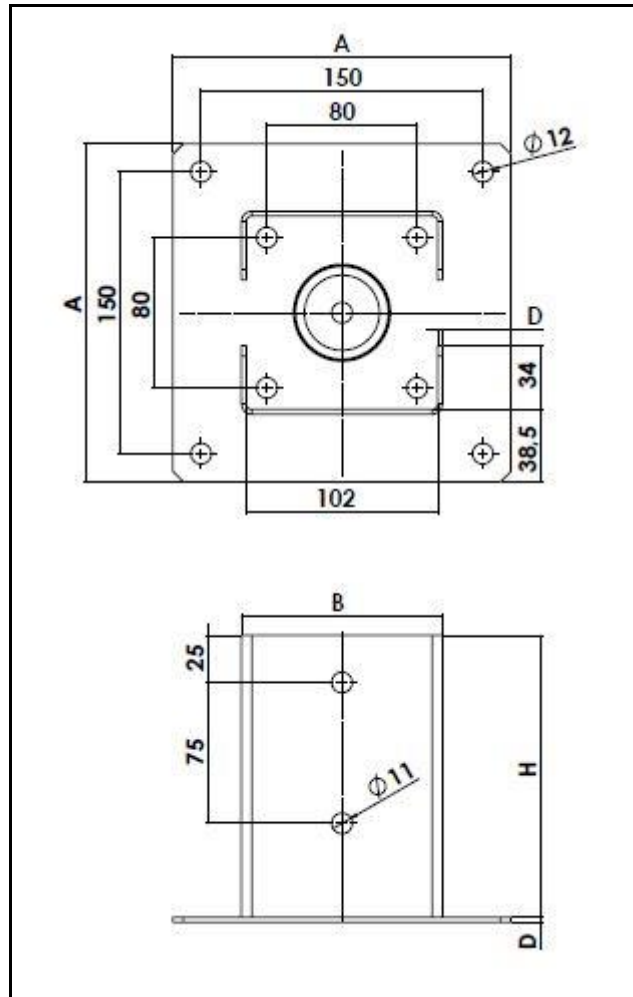
Symbol	Dimensions, mm				Quantity of openings	
	H	A	B	D	Ø11	Ø12
PSP 140	150	220	141	2.5	4	5
PSP 160	200	220	161	2.5	4	5
PSP 200	200	260	201	2.5	4	5



**Figure 7** Type PSPW 100

**Table 9** PSPW three-dimensional nailing plate symbols and dimensions

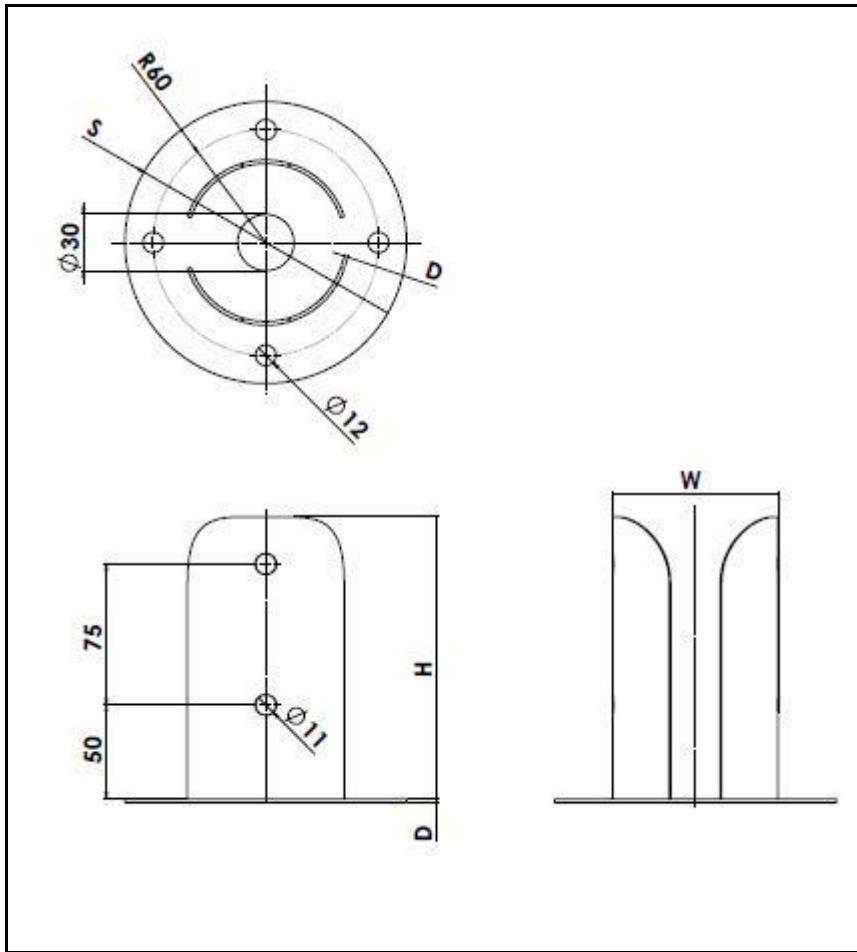
Symbol	Dimensions, mm				Quantity of openings	
	H	A	B	D	Ø11	Ø12
PSPW 90	150	19	92	2	4	5
PSPW 100	150	34	102	2.5	4	5
PSPW 120	150	34	122	2.5	4	5
PSPW 140	200	43	142	3	4	5
PSPW 150	200	43	152	3	4	5
PSPW 160	200	53	162	3	4	5
PSPW 200	200	68	202	3	4	5



**Figure 8** Type PSPD 100

**Table 10** PSPD three-dimensional nailing plate symbols and dimensions

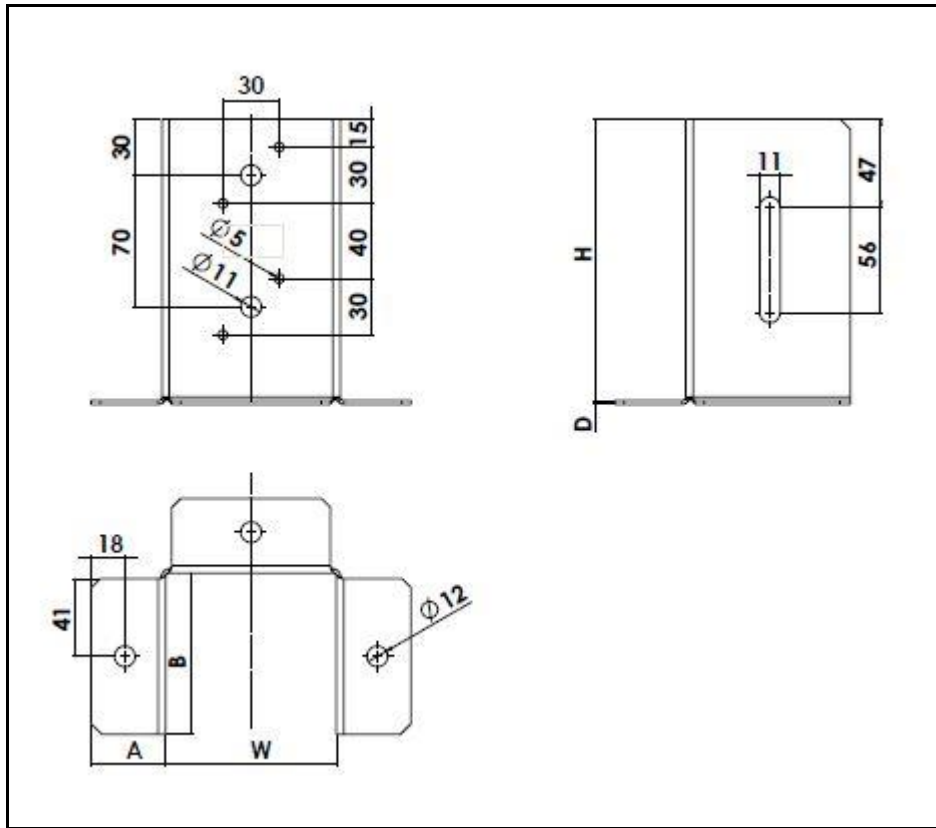
Symbol	Dimensions, mm				Quantity of openings	
	H	A	B	D	Ø11	Ø12
PSPD 70	150	150	72	2	4	8
PSPD 90	150	150	92	2	4	8
PSPD 100	150	180	102	2	4	8
PSPD 120	150	180	122	2.5	4	8
PSPD 140	200	220	142	3	4	8
PSPD 150	200	220	152	3	4	8
PSPD 160	200	220	162	3	4	8
PSPD 200	200	260	202	3	4	8



**Figure 9** Type PSPOD 80

**Table 11** PSPOD three-dimensional nailing plate symbols and dimensions

Symbol	Dimensions, mm				Quantity of openings	
	H	S	W	D	Ø11	Ø12
PSPOD 80	150	150	82	2	4	4
PSPOD 90	150	165	92	2	4	4
PSPOD 100	180	180	102	2.5	4	4
PSPOD 120	180	210	122	2.5	4	4



**Figure 10** Type PSP DX 90

**Table 12** PSP DX three-dimensional nailing plate symbols and dimensions

Symbol	Dimensions, mm					Quantity of openings			
	H	W	A	B	D	Ø5	Ø7	Ø11	Ø12
PSP DX 45	100.5	46	28	41	1.5	-	2	-	3
PSP DX 70	150	71	40	66	2	4	-	2	3
PSP DX 90	150	91	40	86	2	4	-	2	3
PSP DX 100	150	101	40	89	2	4	-	2	3
PSP DX 120	150	121	40	105	2	4	-	2	3
PSP DX 140	150	141	40	105	2	4	-	2	4
PSP DX 150	150	151	40	105	2.5	4	-	2	4



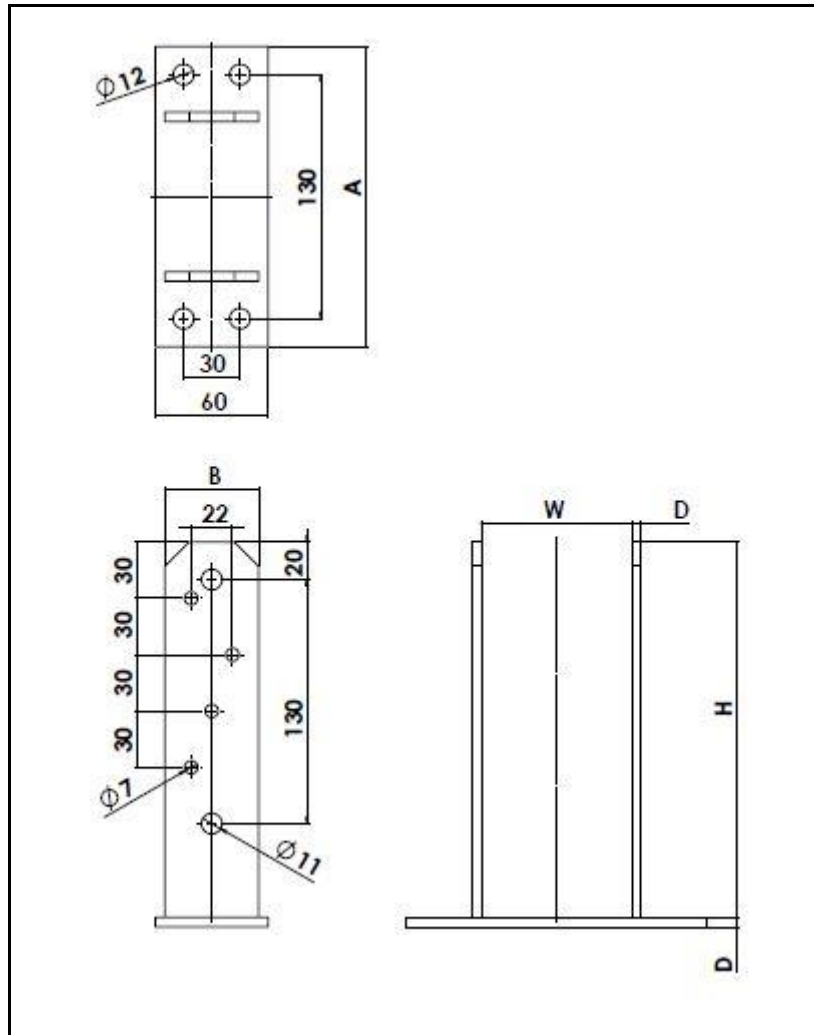
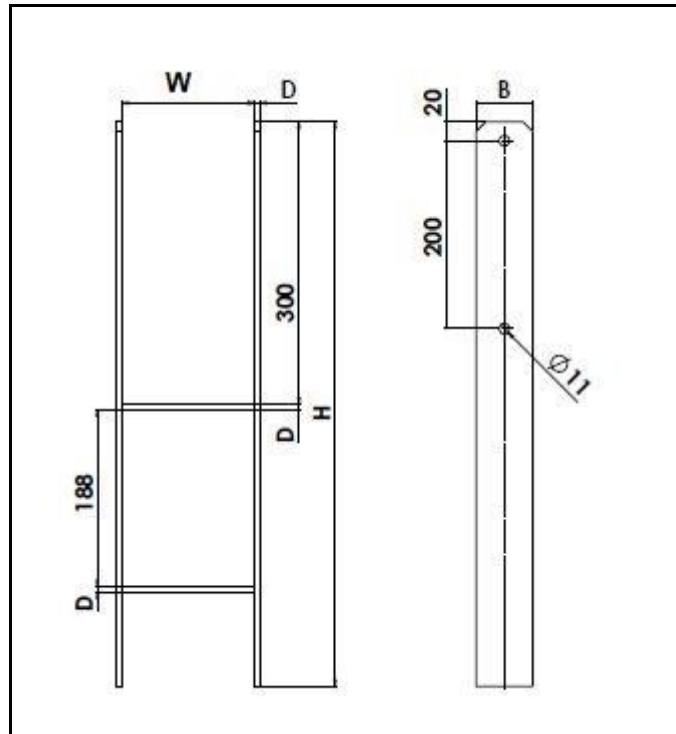


Figure 11 Type PST 80

Table 13 PST three-dimensional nailing plate symbols and dimensions

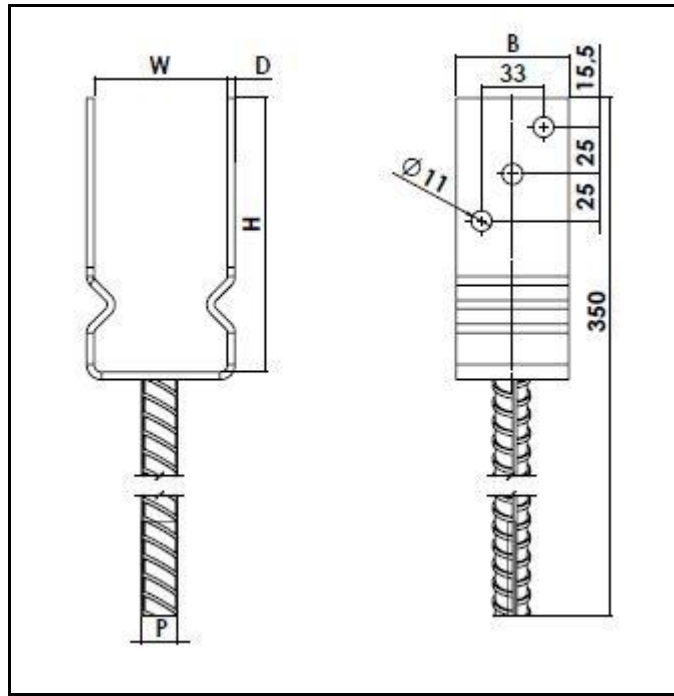
Symbol	Dimensions, mm				Quantity of openings		
	W	A	B	D	Ø7	Ø11	Ø12
PST 75	75	160	50	5	8	4	4
PST 80	80	160	50	5	8	4	4
PST 150	150	230	50	5	8	4	4
PST 160	160	250	50	5	8	4	4
PST 200	200	280	50	5	8	4	4



**Figure 12** Type PSH 140

**Table 14** PSH three-dimensional nailing plate symbols and dimensions

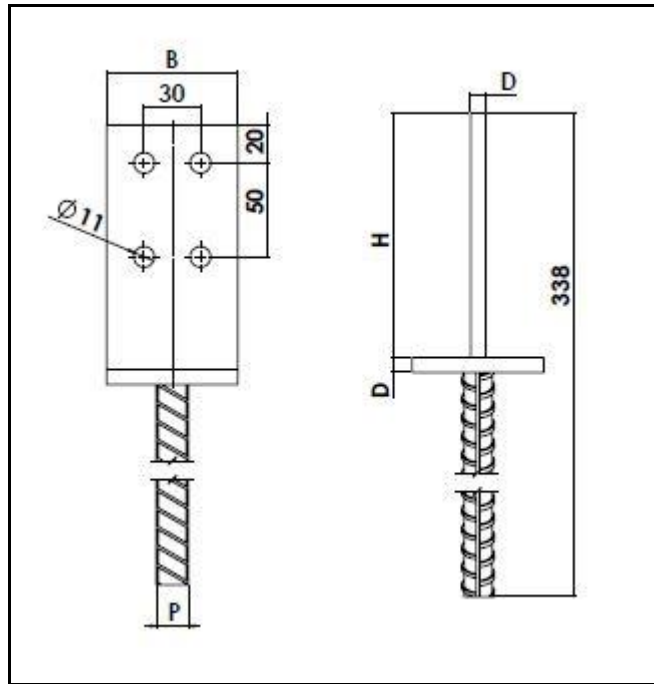
Symbol	Dimensions, mm				Quantity of openings
	W	H	B	D	Ø11
PSH 70	71	600	60	6	4
PSH 80	81	600	60	6	4
PSH 90	91	600	60	6	4
PSH 100	101	600	60	6	4
PSH 120	121	600	60	6	4
PSH 140	141	600	60	6	4
PSH 160	161	600	60	6	4
PSH 200	201	600	60	6	4



**Figure 13** Type PSZ 70

**Table 15** PSZ three-dimensional nailing plate symbols and dimensions

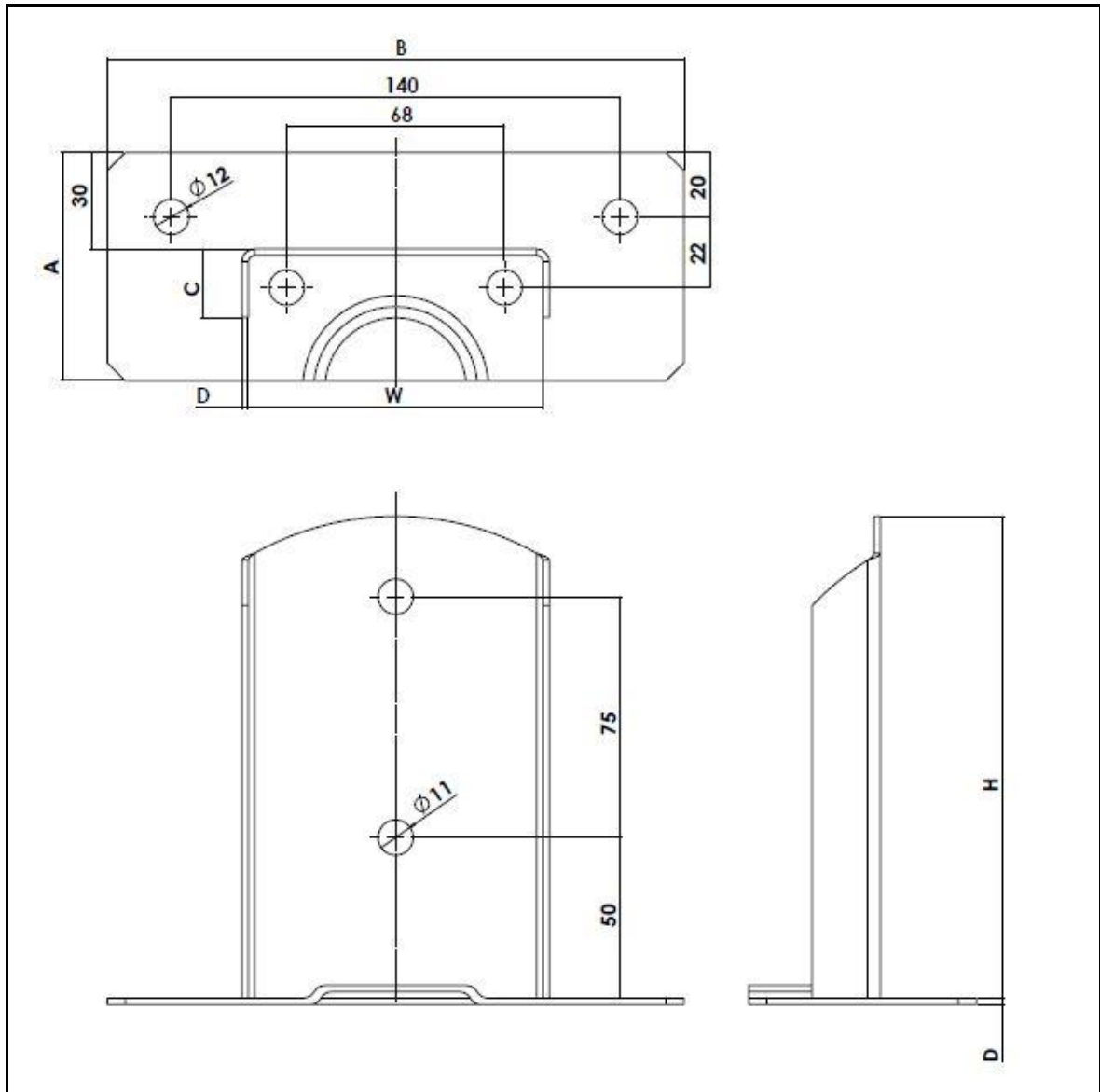
Symbol	Dimensions, mm					Quantity of openings
	H	W	B	D	P	Ø11
PSZ 60	146	61	60	4	18	6
PSZ 70	146	71	60	4	18	6
PSZ 90	146	91	60	4	18	6
PSZ 100	146	101	60	4	18	6
PSZ 120	146	121	60	4	18	6
PSZ 140	146	141	60	4	18	6



**Figure 14** Type PSW 70

**Table 16** PSW three-dimensional nailing plate symbols and dimensions

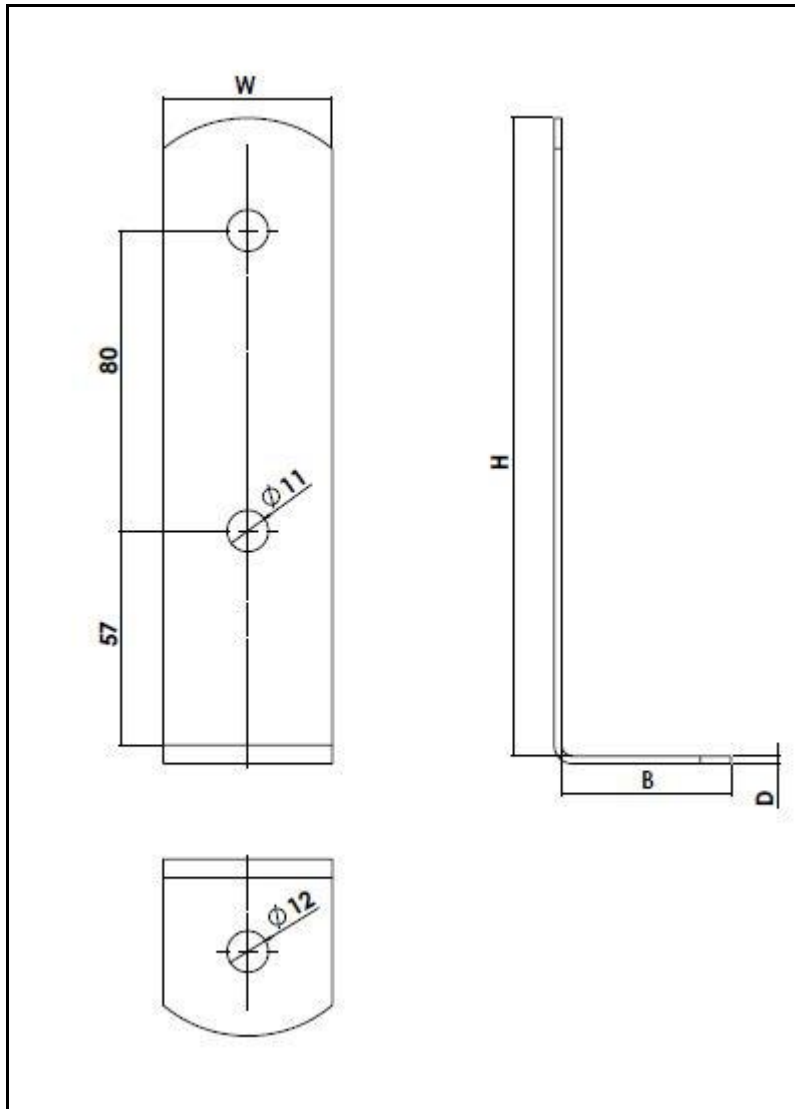
Symbol	Dimensions, mm				Quantity of openings
	H	B	D	P	Ø11
PSW 70	130	70	8	16	4
PSW 90	130	90	8	16	4



**Figure 15** Type PSD 90

**Table 17** PSD three-dimensional nailing plate symbols and dimensions

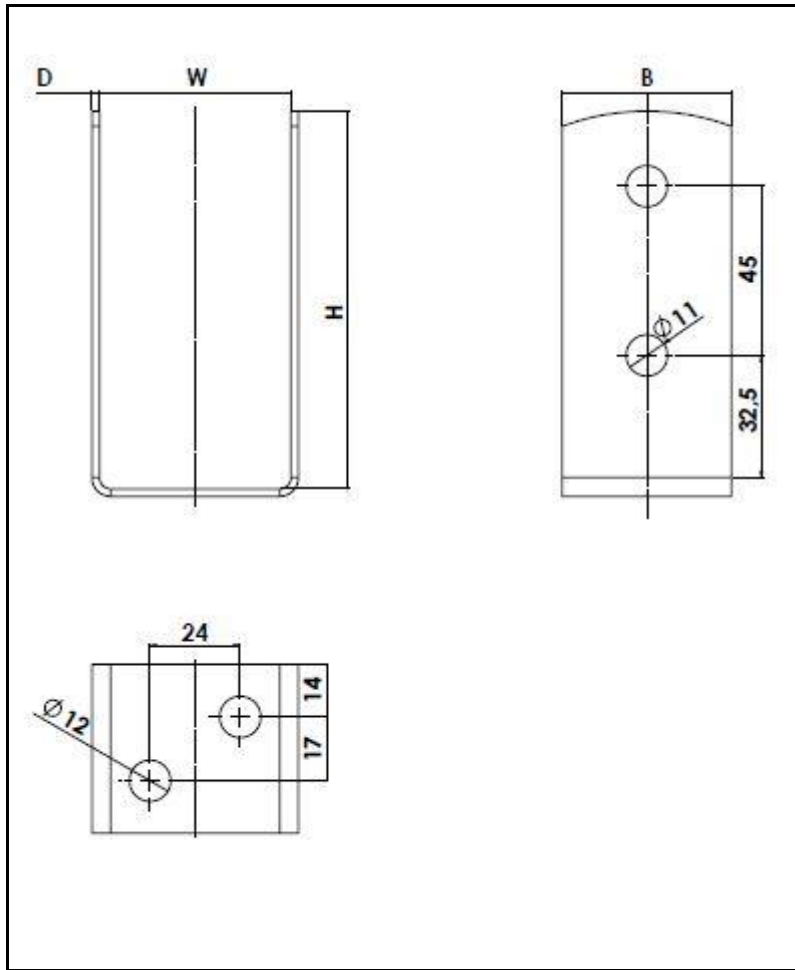
Symbol	Dimensions, mm						Quantity of openings	
	W	H	A	B	C	D	Ø11	Ø12
PSD 90	92	150	71	180	21	2	2	4
PSD 100	102	150	75	180	37	2.5	2	4
PSD 120	122	150	85	190	37	2.5	2	4
PSD 140	142	200	90	210	46	3	2	4
PSD 160	162	200	100	250	56	3	2	4
PSD 200	202	200	120	300	71	3	2	4



**Figure 16** Type PSC 45

**Table 18** PSC three-dimensional nailing plate symbols and dimensions

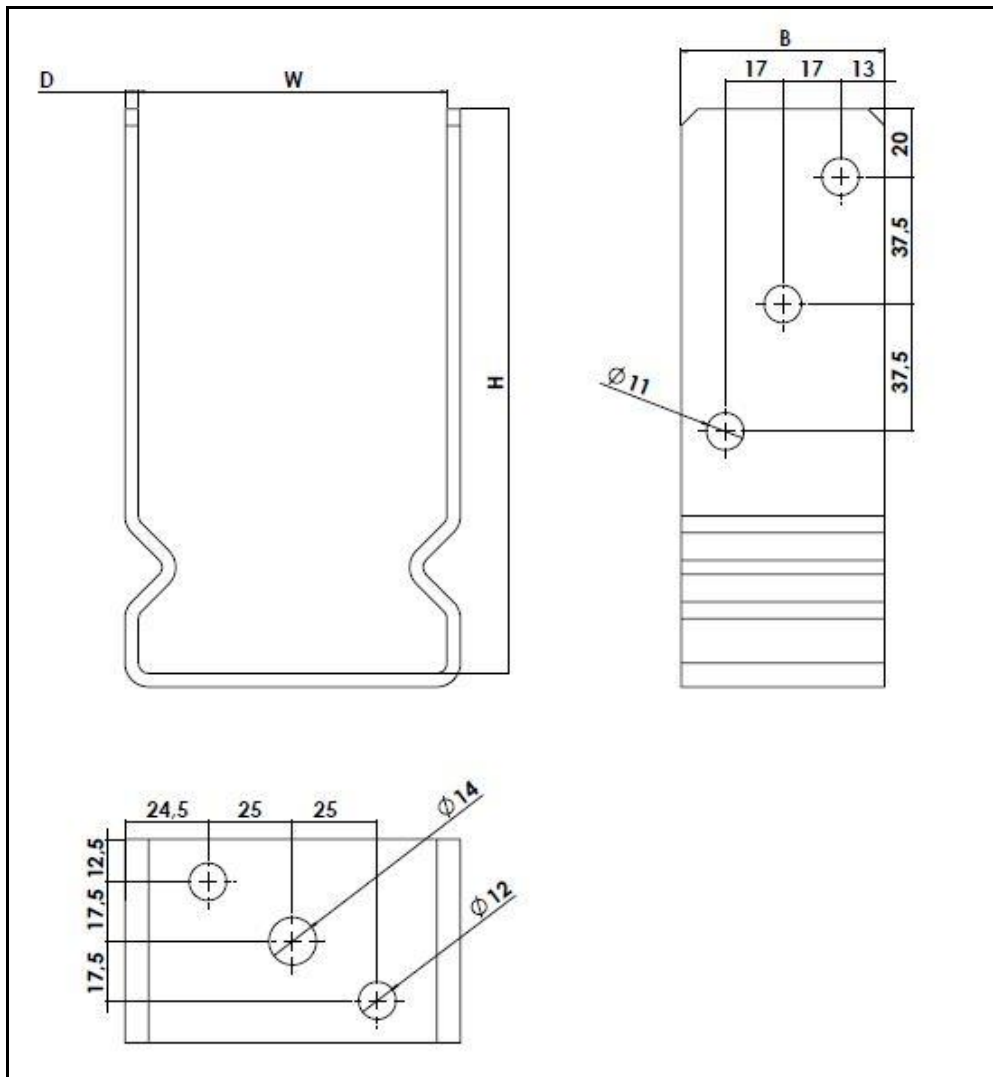
Symbol	Dimensions, mm				Quantity of openings	
	W	H	B	D	Ø11	Ø12
PSC 45	45	170	45	2	2	1
PSC 60	60	170	60	2	2	1
PSC 75	75	200	60	3	2	2
PSC 90	90	200	60	3	2	2



**Figure 17** Type PSOL 50

**Table 19** PSOL three-dimensional nailing plate symbols and dimensions

Symbol	Dimensions, mm				Quantity of openings	
	W	H	B	D	Ø11	Ø12
PSOL 45	45	100,5	45	2	4	2
PSOL 50	51	100,5	45	2	4	2
PSOL 60	61	100,5	45	2	4	2
PSOL 70	71	120	71	2.5	4	2
PSOL 90	91	120	71	2.5	4	2
PSOL 100	101	120	71	2.5	4	2

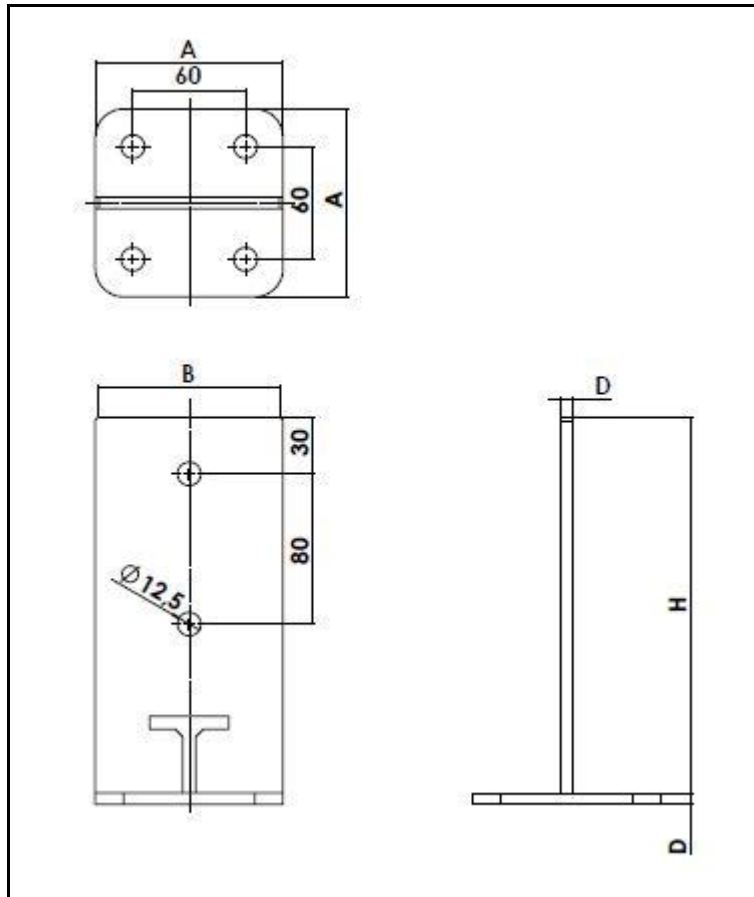


**Figure 18** Type PSOZ 90

**Table 20** PSOZ three-dimensional nailing plate symbols and dimensions

Symbol	Dimensions, mm				Quantity of openings		
	W	H	B	D	Ø11	Ø12	Ø14
PSOZ 70	71	166	60	4	6	2	-
PSOZ 80	81	166	60	4	6	2	-
PSOZ 90	91	166	60	4	6	2	1
PSOZ 100	101	166	60	4	6	2	1
PSOZ 120	121	166	60	4	6	2	1

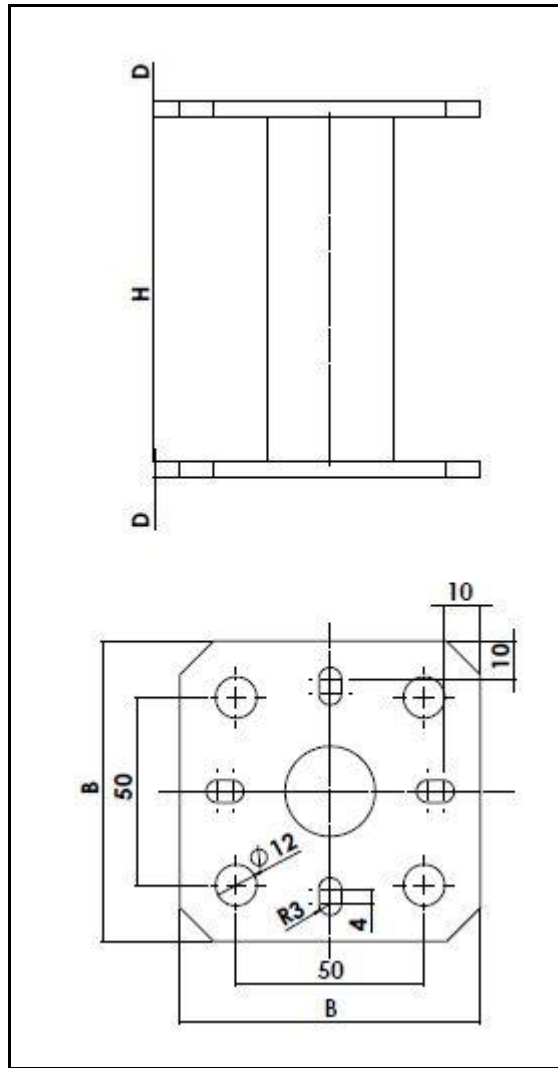




**Figure 19** Type PUW 100

**Table 21** PUW three-dimensional nailing plate symbols and dimensions

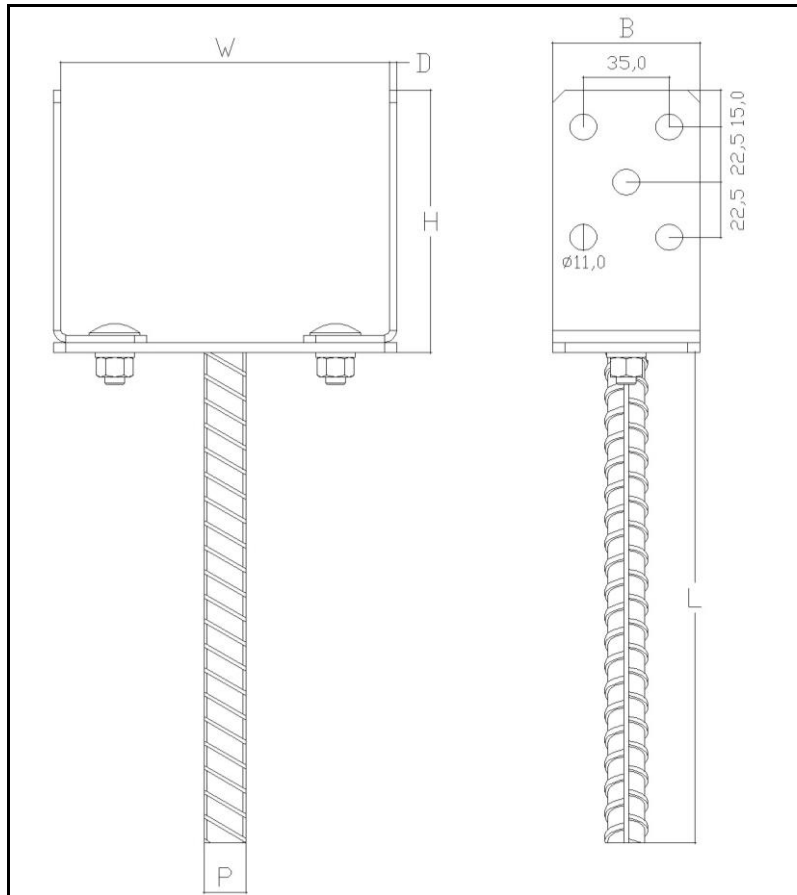
Symbol	Dimensions, mm				Quantity of openings
	H	A	B	D	Ø12.5
PUW 90	200	90	90	6	6
PUW 100	200	100	100	6	6
PUW 120	250	120	120	8	6
PUW 140	250	140	140	8	6



**Figure 20** Type PMF 80-100

**Table 22** PMF three-dimensional nailing plate symbols and dimensions

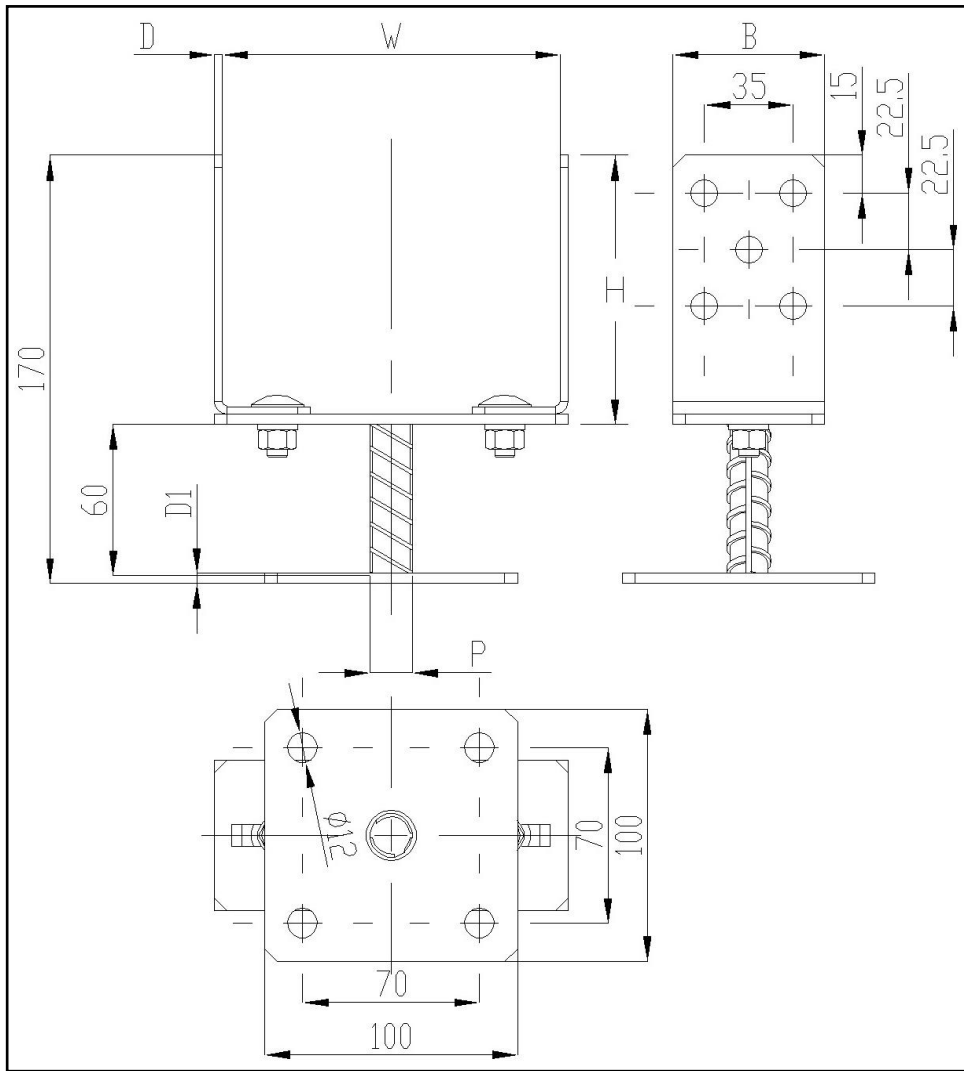
Symbol	Dimensions, mm			Quantity of openings
	H	B	D	Ø12
PMF 80-100	100	80	4	8
PMF 80-150	150	80	4	8
PMF 80-200	200	80	4	8
PMF 100-100	100	100	4	8
PMF 100-150	150	100	4	8
PMF 100-200	200	100	4	8



**Figure 21** Type PSRL 0-160

**Table 23** PSRL 0-160 three-dimensional nailing plate symbols and dimensions

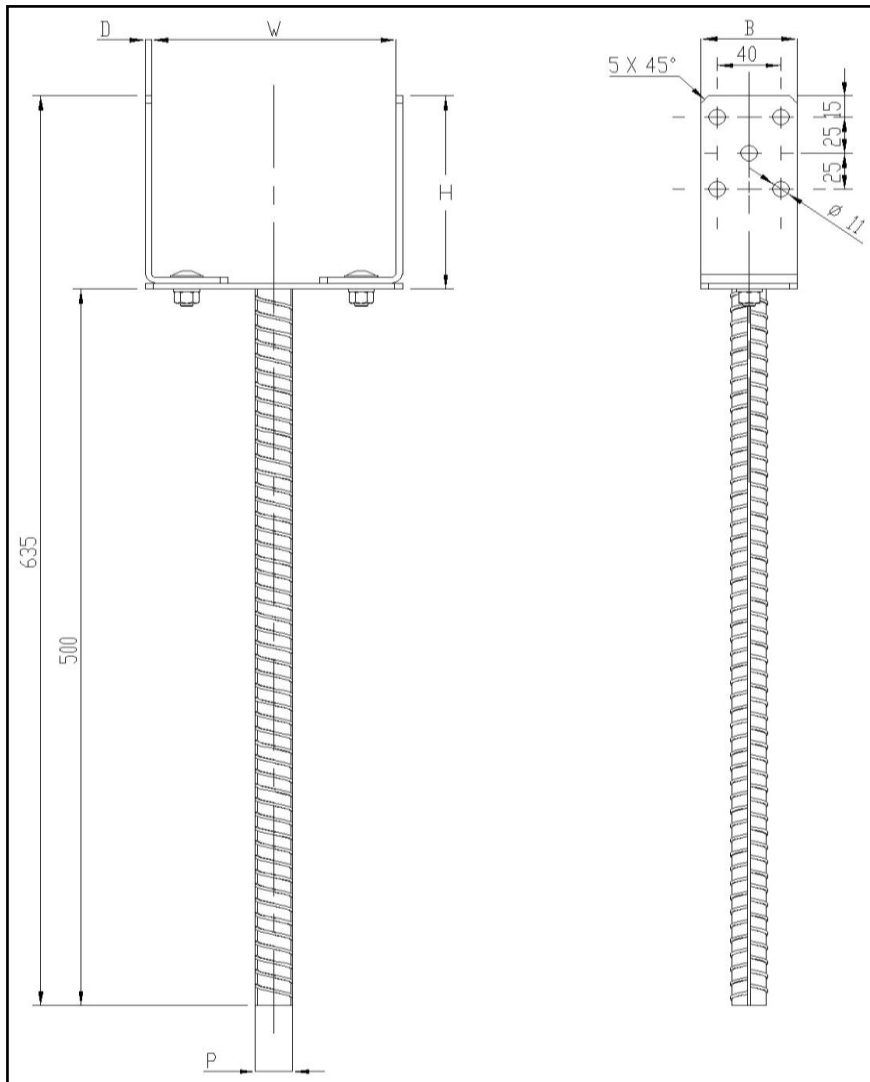
Symbol	Dimensions, mm						Quantity of openings
	W	H	B	D	P	L	Ø11
PSRL 0-160	0-160	107	60	3	18	200	10
PSRL 0-160/400	0-160	107	60	3	20	400	10



**Figure 22** Type PSRLT 0-160

**Table 24** PSRLT 0-160 three-dimensional nailing plate symbols and dimensions

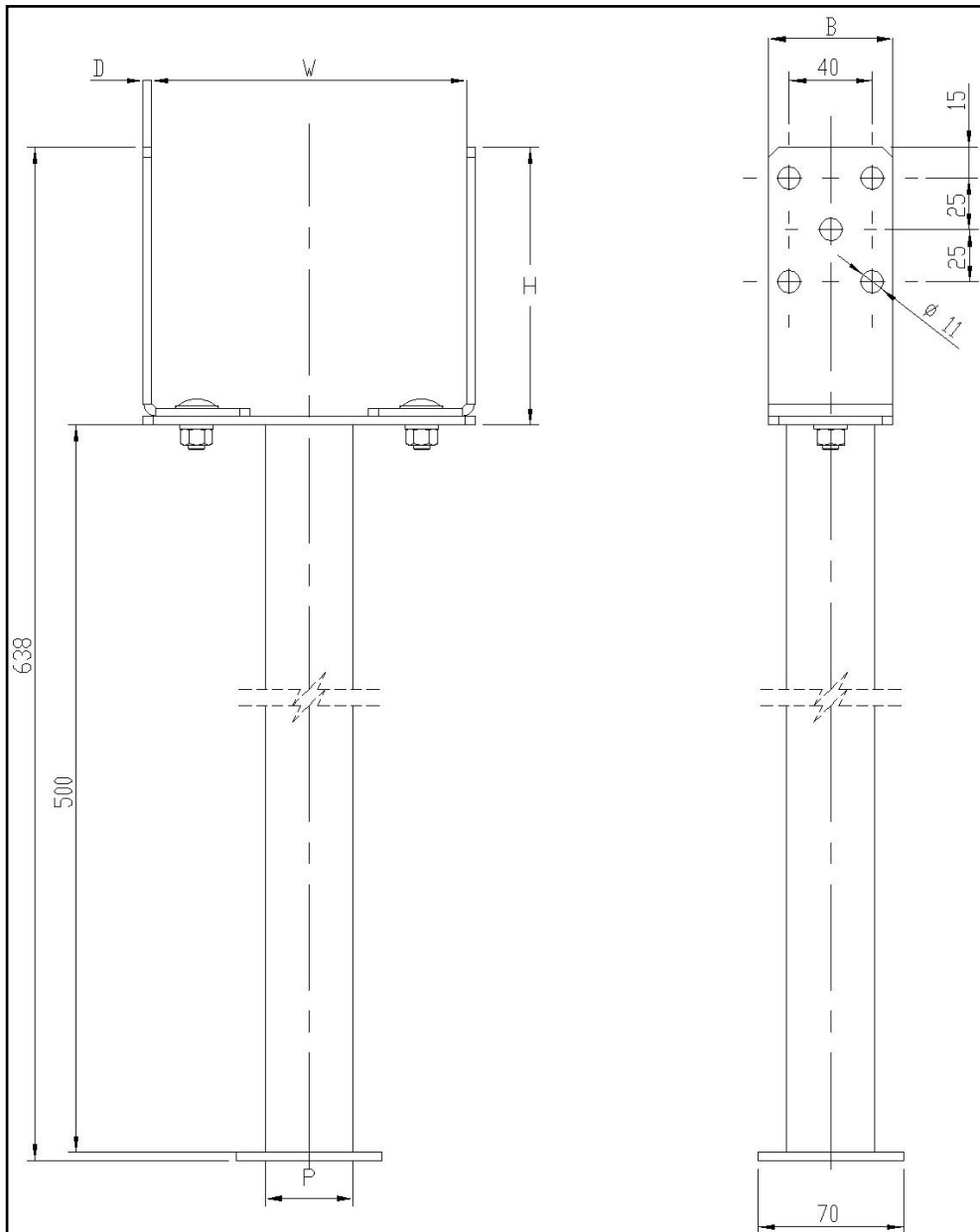
Symbol	Dimensions, mm						Quantity of openings	
	W	H	B	D	D1	P	Ø11	Ø12
PSRLT 0-160	0-160	107	60	3	4	18	10	4



**Figure 23** Type PSRU 60-200/500

**Table 25** PSRU 60-200/500 three-dimensional nailing plate symbols and dimensions

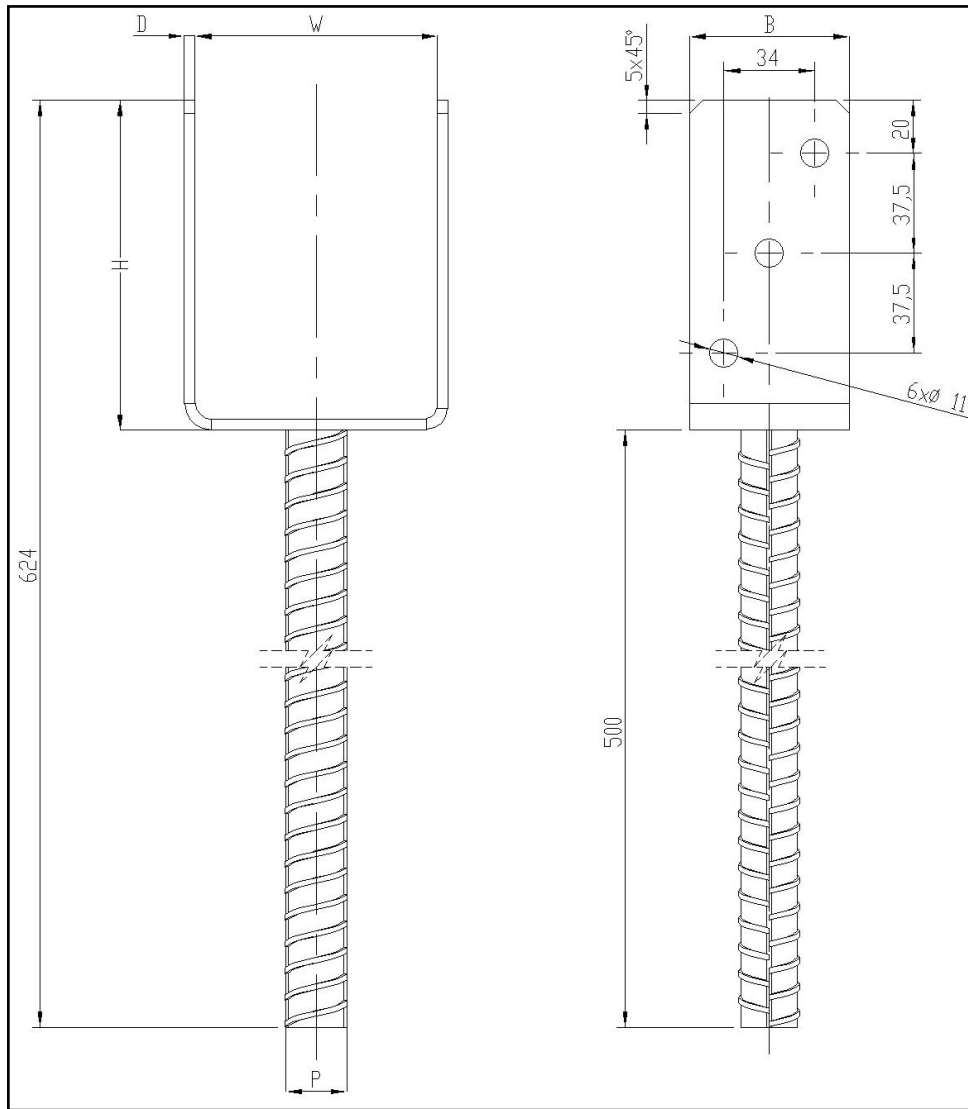
Symbol	Dimensions, mm					Quantity of openings
	W	H	B	D	P	Ø11
PSRU 60-200/500	0-200	135	60	4	22	10



**Figure 24** Type PSRU 60-200 R500

**Table 26** PSRU 60-200 R500 three-dimensional nailing plate symbols and dimensions

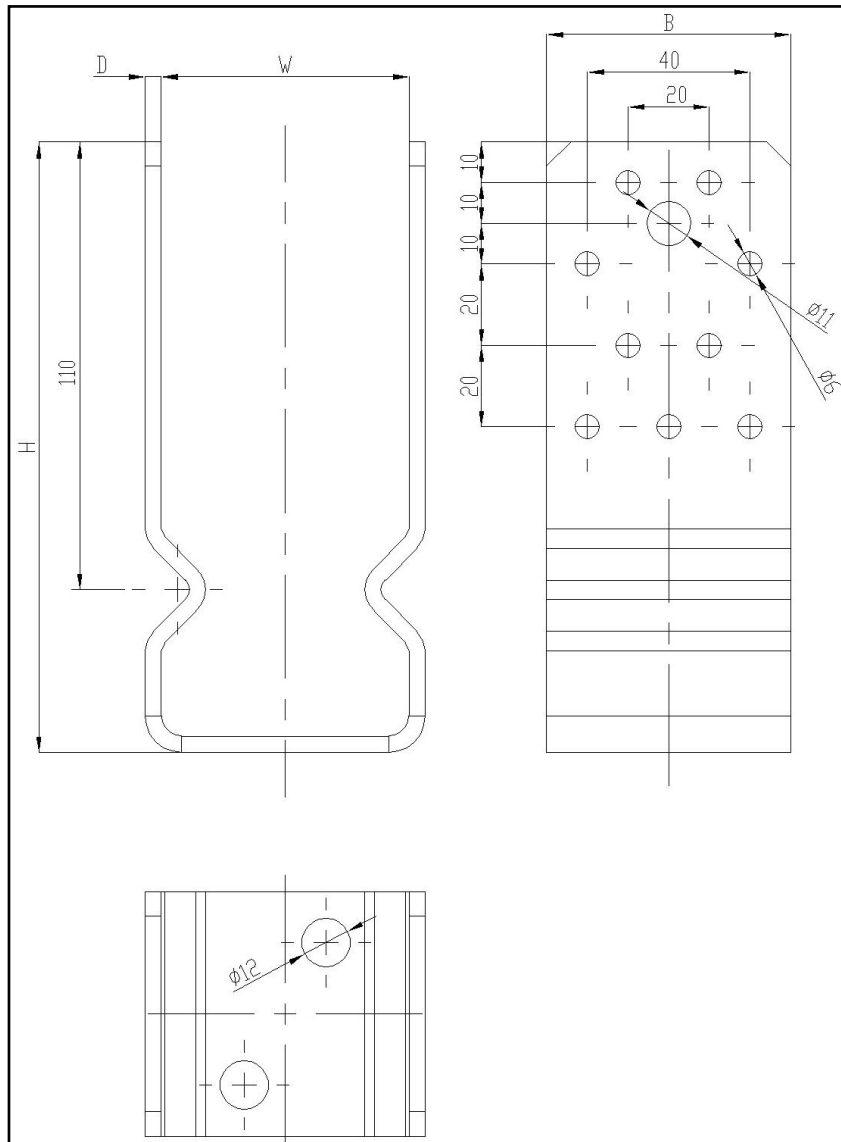
Symbol	Dimensions, mm					Quantity of openings
	W	H	B	D	P	Ø11
PSRU 60-200 R500	0-200	138	60	4	42.4x2	10



**Figure 25** Type PS /500

**Table 27** PS /500 three-dimensional nailing plate symbols and dimensions

Symbol	Dimensions, mm					Quantity of openings
	W	H	B	D	P	Ø11
PS 90U/500	91	124	60	4	22	6
PS 100U/500	101	124	60	4	22	6
PS 120U/500	121	124	60	4	22	6
PS 140U/500	141	124	60	4	22	6
PS 160U/500	162	124	60	4	22	6

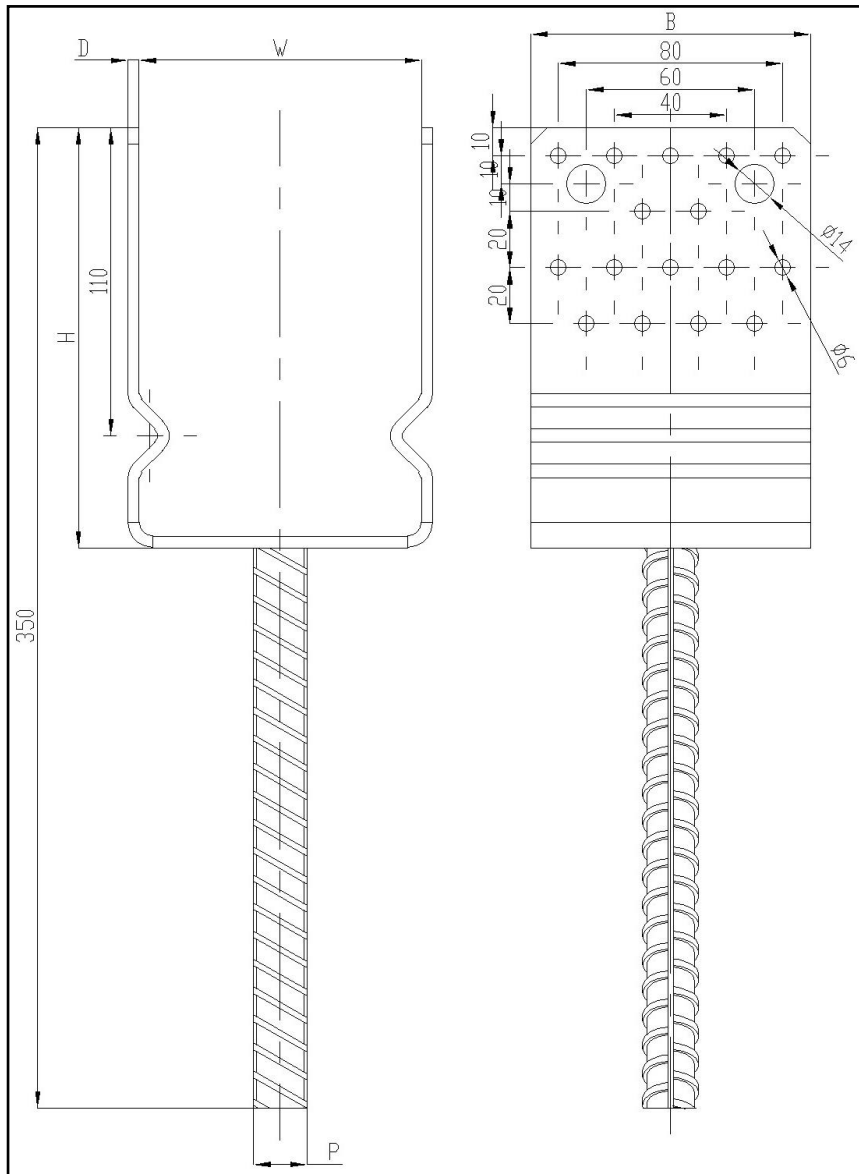


**Figure 26** Type PSSOZ

**Table 28** PSSOZ three-dimensional nailing plate symbols and dimensions

Symbol	Dimensions, mm				Quantity of openings			
	W	H	B	D	Ø6	Ø11	Ø12	Ø14
PSSOZ 60	61	150	60	4	18	2	2	-
PSSOZ 80	81	150	60	4	26	2	2	-
PSSOZ 100	101	150	60	4	32	-	2	5
PSSOZ 120	121	150	60	4	40	-	2	5
PSSOZ 140	141	150	60	4	40	-	2	5
PSSOZ 160	161	150	60	4	40	-	2	5

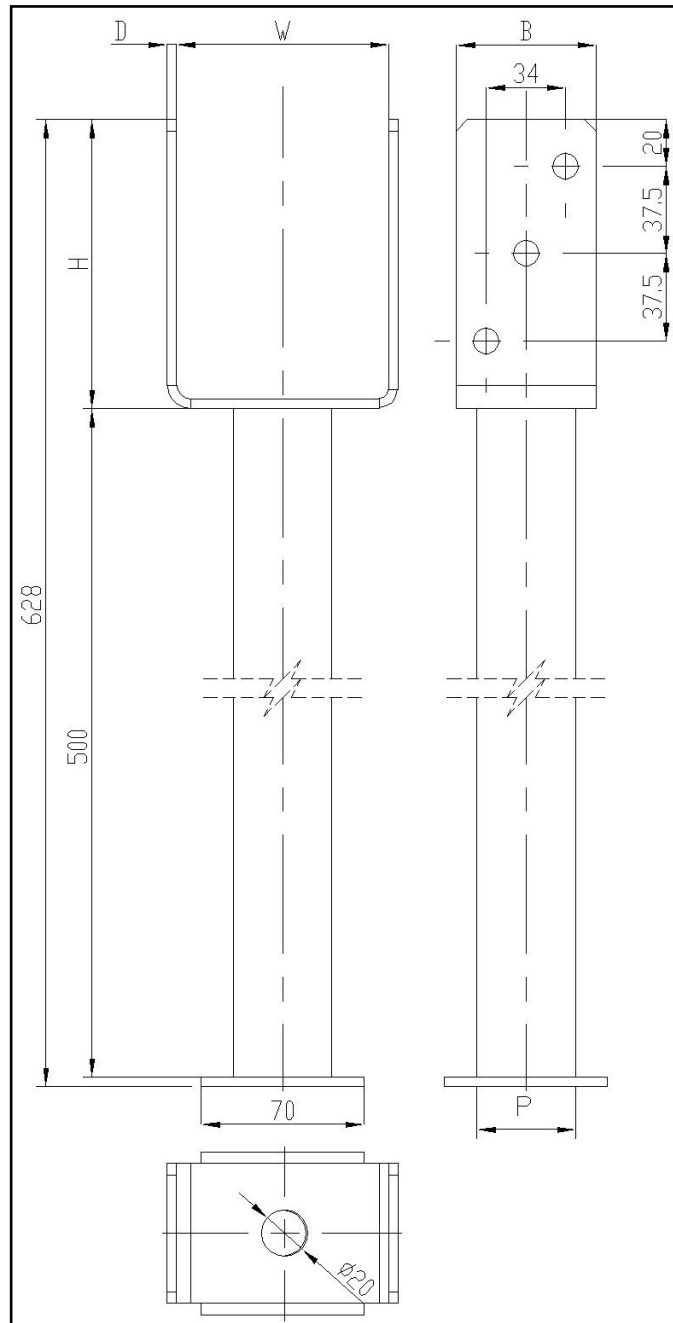




**Figure 27** Type PSSZ

**Table 29** PSSZ three-dimensional nailing plate symbols and dimensions

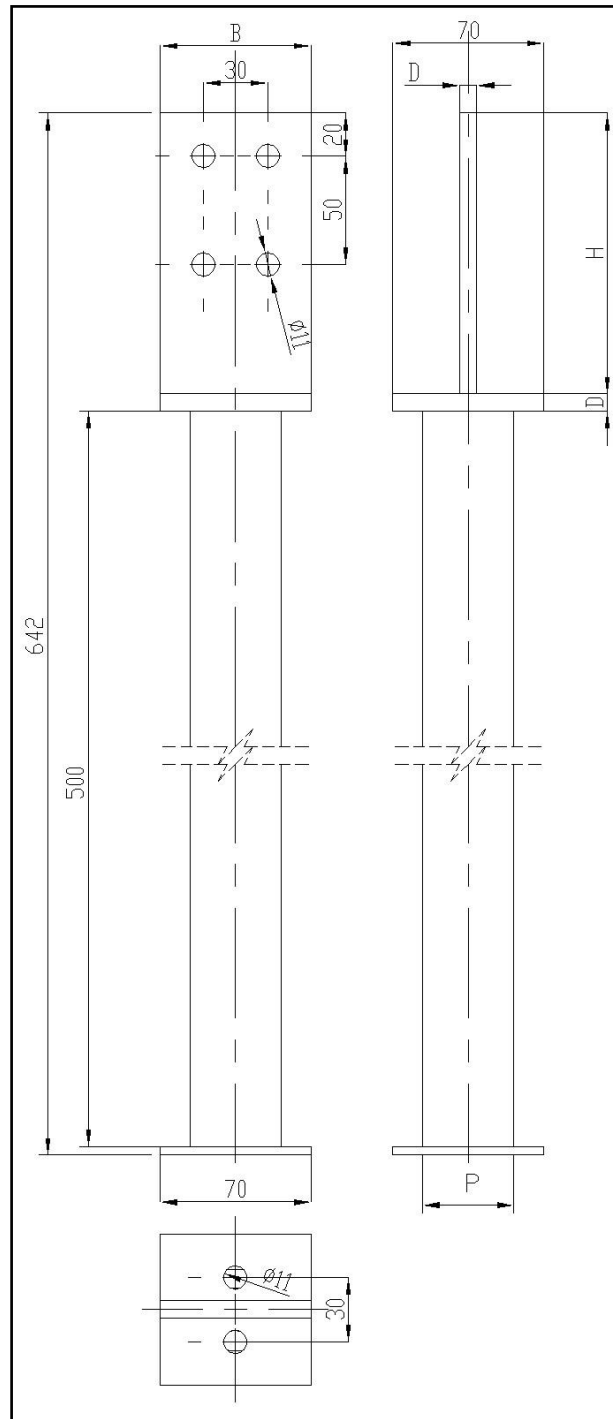
Symbol	Dimensions, mm					Quantity of openings		
	W	H	B	D	P	Ø6	Ø11	Ø14
PSSZ 60	61	150	60	4	18	18	2	-
PSSZ 80	81	150	80	4	18	26	2	-
PSSZ 100	101	150	100	4	18	32	-	4
PSSZ 120	121	150	120	4	18	40	-	4
PSSZ 140	141	150	120	4	18	40	-	4
PSSZ 160	161	150	120	4	18	40	-	4



**Figure 28** Type PS R500

**Table 30** PS R500 three-dimensional nailing plate symbols and dimensions

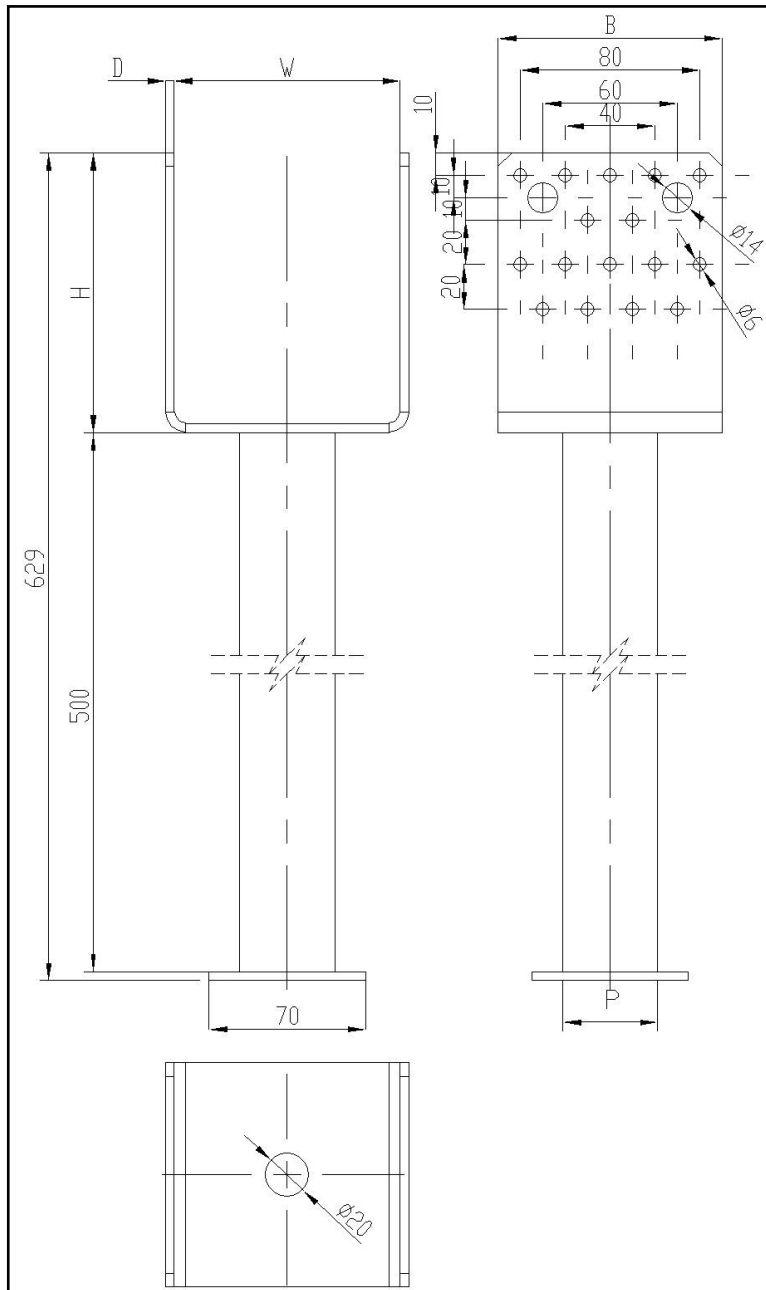
Symbol	Dimensions, mm					Quantity of openings	
	W	H	B	D	P	Ø11	Ø20
PS 90 R500	91	124	60	4	42.4x2	6	2
PS 100 R500	101	124	60	4	42.4x2	6	2
PS 120 R500	121	124	60	4	42.4x2	6	2
PS 140 R500	141	124	60	4	42.4x2	6	2
PS 140 R500	162	124	60	4	42.4x2	6	2



**Figure 29** Type PSW R500

**Table 31** PSW R500 three-dimensional nailing plate symbols and dimensions

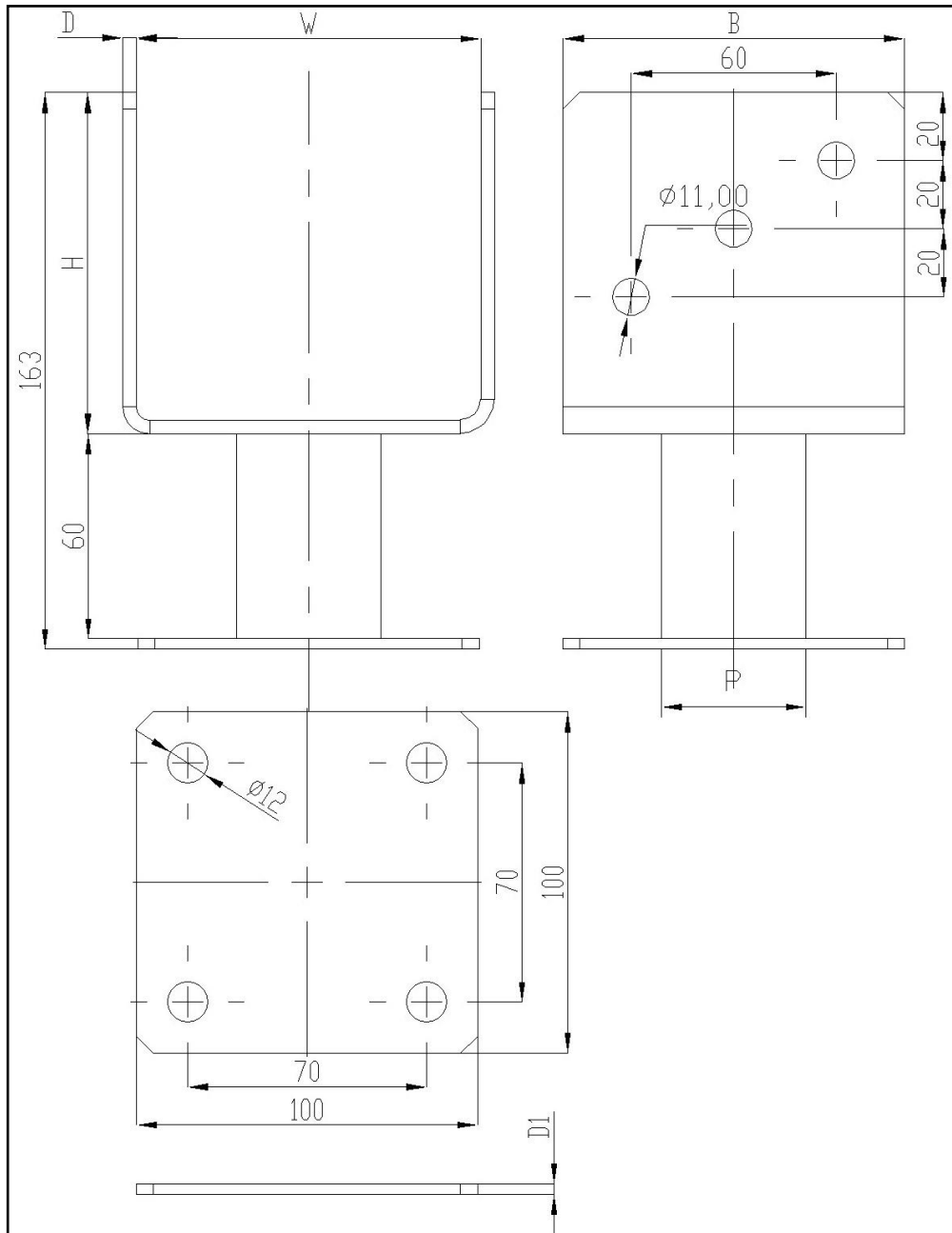
Symbol	Dimensions, mm				Quantity of openings	
	H	B	D	P	Ø11	Ø20
PSW 90 R500	130	70	8	42.4x2	6	1
PSW 100 R500	130	90	8	42.4x2	6	1



**Figure 30** Type PSS R500

**Table 32** PSS R500 three-dimensional nailing plate symbols and dimensions

Symbol	Dimensions, mm					Quantity of openings		
	W	H	B	D	P	Ø6	Ø14	Ø20
PSS 100 R500	101	125	100	4	42.4x2	32	4	1
PSS 120 R500	121	125	120	4	42.4x2	40	4	1
PSS 140 R500	141	125	120	4	42.4x2	40	4	1
PSS 160 R500	161	125	120	4	42.4x2	40	4	1

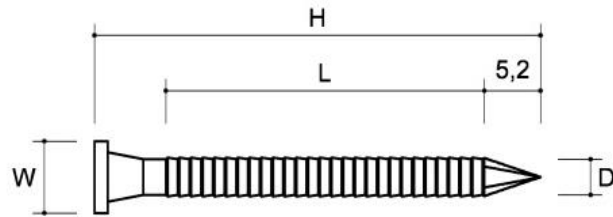


**Figure 31** Type PMFU

**Table 33** PMFU three-dimensional nailing plate symbols and dimensions

Symbol	Dimensions, mm						Quantity of openings	
	W	H	B	D	D1	P	Ø11	Ø12
PMFU 100	101	100	100	4	3	42.4x2	6	4
PMFU 120	121	100	100	4	3	42.4x2	6	4
PMFU 140	141	100	100	4	3	42.4x2	6	4
PMFU 160	162	100	100	4	3	42.4x2	6	4

### Dowel type connectors



ANG 50

Figure 32 Type ANG 50

Table 34 Type ANG 50 dimensions

Symbol	Dimensions [mm]				Standard	DoP No.
	D	H	L	W		
ANG 50 Anchor nail with flat head	4	50	36.8	8	EN 14592+A1	DWU 30-20232 AN (issued on 02/01/2018) DoP02 (issued on 28/05/2019)

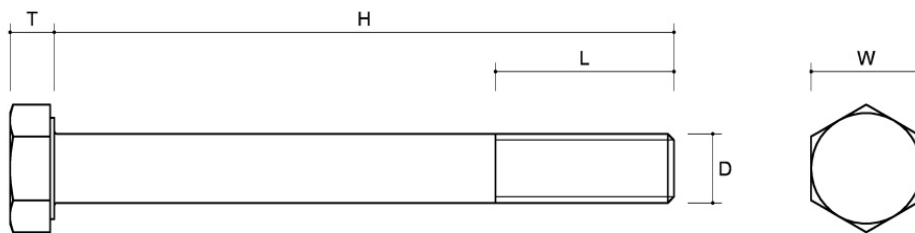
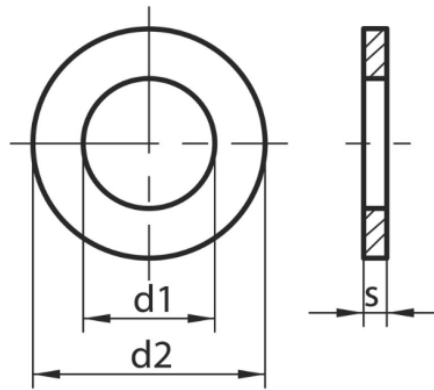


Figure 33 Screw type M

Table 35 Screw type M dimensions

Symbol	Dimensions [mm]					Standard	DoP No.
	D	H	L	W	T		
M12x160	12	160	36	18	7.5	EN 15048-1 ISO 4014	NKJ/CPR/20170201 (issued on 01.02.2017)
M12x140		140					
M12x120		120	30				
M12x110		110					
M10x60	10	60	26	16/17	6.4		
M10x80		80					
M10x90		90					

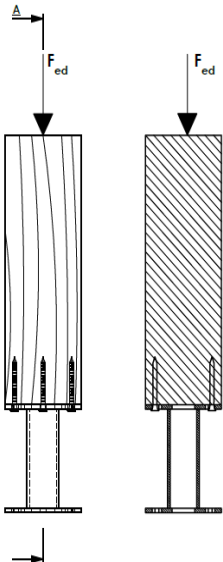
Symbol	Dimensions [mm]					Standard	DoP No.
	D	H	L	W	T		
M10x100		100	36				
M10x110		110					
M10x120		120					
M10x130		130					
M10x140		140					
M10x160		160					
M10x180		180					
M10x220		220					
M8x60	8	60	22	13	5.2		



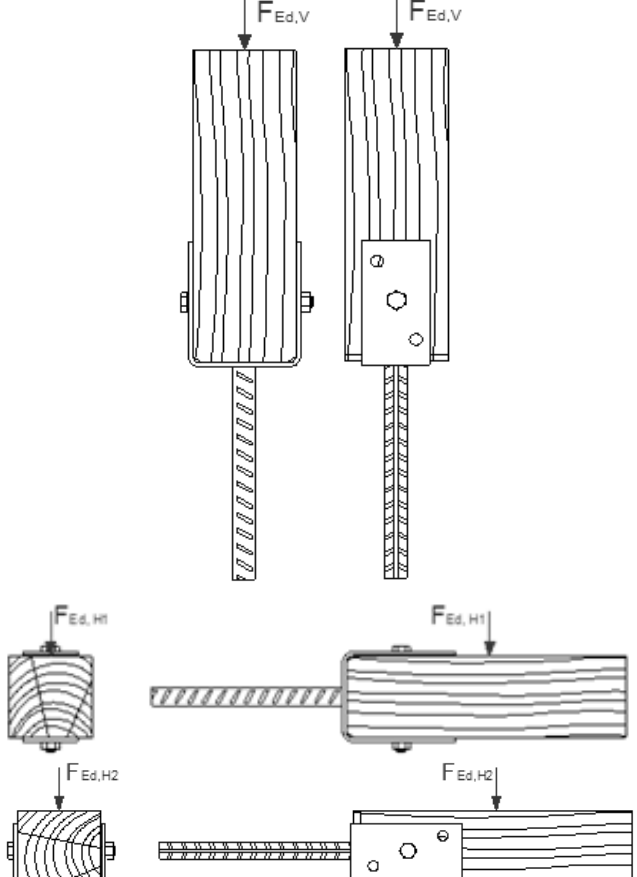
**Figure 34** Washer type M

**Table 36** Washer M type dimensions

Symbol	Dimensions [mm]			Standard	DoP No.
	d <sub>1</sub>	d <sub>2</sub>	s		
M12	13	24	2.5	EN 15048-1 ISO 7089	NKJ/CPR/2015-09-01 rev.02 (issued on 15/01/2016)
M10	10.5	20	2.0		
M8	8.4	16	1.6		

No.	Scheme	Connector types
1		<p>PMF 80-100                  PMF 80-150                  PMF 80-200                  PMF 100-100                  PMF 100-150                  PMF 100-200</p>

**Figure 35** Scheme 1

No.	Scheme	Connector types
2		<p>PS 75U                  PS 150U                  PS 160U</p>

**Figure 36** Scheme 2



No.	Scheme	Connector type
3		<p>PSC 45  PSC 60  PSC 75  PSC 90</p>

**Figure 37** Scheme 3

No.	Scheme	Connector type
4		<p>PSD 90  PSD 100  PSD 120  PSD 140  PSD 160  PSD 200</p>

**Figure 38** Scheme 4

No.	Scheme	Connector type
5		<p>PSH 75  PSH 80  PSH 90  PSH 100  PSH 120  PSH 140  PSH 160  PSH 200</p>

**Figure 39** Scheme 5

No.	Scheme	Connector type
6		PSL 45U

Figure 40 Scheme 6

No.	Scheme	Connector type
7		<p>           PSO 50            PSO 60            PSO 70            PSO 80            PSO 90            PSO 100            PSO 120         </p>

**Figure 41** Scheme 7

No.	Scheme	Connector type
8	<p>The diagram illustrates six views of a connector under a downward force <math>F_{ed}</math>. The views are arranged in two columns and three rows. The top row shows two vertical side views; the left one has a dimension of 10 at the bottom, and the right one shows a control panel with a switch and two indicator lights. The middle row shows two horizontal side views; the left one is a simple rectangular block, and the right one has a dimension of 10 at the top. The bottom row shows two end views; the left one shows a circular face with a textured pattern, and the right one shows a rectangular face with a control panel similar to the one in the top-right view, with a dimension of 10 at the bottom.</p>	<p>PSOL 45  PSOL 50  PSOL 60  PSOL 70  PSOL 90  PSOL 100</p>

Figure 42 Scheme 8

No.	Scheme	Connector type
9		<p>PSOZ 60          PSOZ 70          PSOZ 90          PSOZ 100          PSOZ 120          PSOZ 140</p>

Figure 43 Scheme 9

No.	Scheme	Connector type
10		<p>PSP 140 PSP 160 PSP 200</p>

Figure 44 Scheme 10



No.	Scheme	Connector type
11		<p>PSP DX 45  PSP DX 70  PSP DX 90  PSP DX 100  PSP DX 120  PSP DX 140  PSP DX 150</p>

Figure 45 Scheme 11

No.	Scheme	Connector type
12		<p>PSPD 70  PSPD 90  PSPD 100  PSPD 120  PSPD 140  PSPD 150  PSPD 160  PSPD 200</p>

Figure 46 Scheme 12

No.	Scheme	Connector type
13		<p>PSPOD 80  PSPOD 90  PSPOD 100  PSPOD 120</p>

Figure 47 Scheme 13

No.	Scheme	Connector type
14	<p>The diagram illustrates a wood-to-wood connector in three views. The top view shows two vertical posts with a downward force <math>F_{ed}</math> applied to each. The side view shows a horizontal beam with a downward force <math>F_{ed}</math> applied to its top surface, and a dimension of 10 is shown at the bottom. The cross-section view shows the beam's profile with a downward force <math>F_{ed}</math> applied to its top surface.</p>	<p>PSPW 70  PSPW 90  PSPW 100  PSPW 120  PSPW 140  PSPW 150  PSPW 160  PSPW 200</p>

Figure 48 Scheme 14

No.	Scheme	Connector type
15		<p>PSS 60  PSS 80  PSS 100  PSS 120  PSS 140</p>

Figure 49 Scheme 15

No.	Scheme	Connector type
16		<p>PST 75  PST 80  PST 150  PST 160  PST 200</p>

Figure 50 Scheme 16

No.	Scheme	Connector type
17		PSW 70 PSW 90

Figure 51 Scheme 17

No.	Scheme	Connector type
18	<p>The scheme illustrates six configurations of PSZ connectors. The top row shows two vertical views: the left one is a plain cylindrical connector, and the right one has a rectangular component with three circular holes on its side. The bottom row shows two horizontal views: the left one is a plain cylindrical connector, and the right one has the same rectangular component with three circular holes. In all views, a downward arrow labeled <math>F_{ed}</math> indicates the applied load. A dimension line labeled '50' indicates the height of the connector above the base surface.</p>	<p>PSZ 60  PSZ 70  PSZ 90  PSZ 100  PSZ 120  PSZ 140</p>

Figure 52 Scheme 18



No.	Scheme	Connector type
19		PUW 90 PUW 100 PUW 120 PUW 140

Figure 53 Scheme 19

No.	Scheme	Connector type
20		<p>PSRL 0-160  PSRL 0-160 400  PSRU 60-200/500</p>

Figure 54 Scheme 20

No.	Scheme	Connector type
21		<p>PSRLT 0-160</p>

Figure 55 Scheme 21

No.	Scheme	Connector type
22		PSRU 60-200 R500

Figure 56 Scheme 22

No.	Scheme	Connector type
23		PS 90U/500 PS 100U/500 PS 120U/500 PS 140U/500 PS 160U/500  PSSZ 60 PSSZ 80 PSSZ 100 PSSZ 120 PSSZ 140 PSSZ 160

Figure 57 Scheme 23

No.	Scheme	Connector type
24		<p>PS 90U R500  PS 100U R500  PS 120U R500  PS 140U R500  PS 160U R500</p> <p>PSW 70 R500  PSW 90 R500</p> <p>PSS 100 R500  PSS 120 R500  PSS 140 R500  PSS 160 R500</p>

Figure 58 Scheme 24

No.	Scheme	Connector type
25		<p>PSSOZ 60  PSSOZ 80  PSSOZ 100  PSSOZ 120  PSSOZ 140  PSSOZ 160</p>

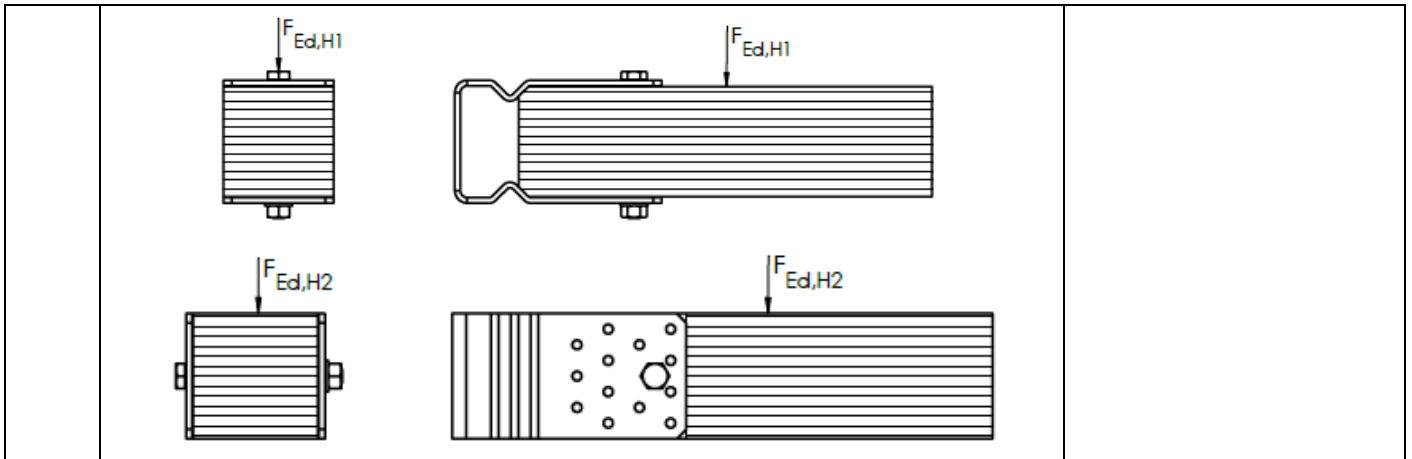


Figure 59 Scheme 25

No.	Scheme	Connector type
26		<p>PMFU 100            PMFU 120            PMFU 140            PMFU 160</p>

Figure 60 Scheme 26

<b>THREE-DIMENSIONAL NAILING PLATES</b>	<b>ANNEX 3</b>
<b>THE CHARACTERISTIC LOAD-CARRYING CAPACITIES OF CONNECTORS</b>	ETA 20/1044

**Table 37** The characteristic load-carrying capacities of connectors

Connector	Load-carrying capacity $N_{Rd,V}$ [kN]*		Load-carrying capacity $N_{Rd,H1}$ [kN]**		Load-carrying capacity $N_{Rd,H2}$ [kN]***		Document No.
	Timber $N_{Rk,V,w}$	Steel $N_{Rd,V,s}$	Timber $N_{Rk,H1,w}$	Steel $N_{Rd,H1,s}$	Timber $N_{Rk,H2,w}$	Steel $N_{Rd,H2,s}$	
PS 75U	92.9	57.3	12.2	9.6	12	1.2	KAO-L-PS-01
PS 150U	187.4	57.3	12.2	9.6	25.7	1.2	
PS 160U	200	57.3	12.2	9.6	28.3	1.2	
PSL 45U	35.5	51.7	2.9	1.6	3	0.8	KAO-L-PSL-01_B
PSS 60	58	57.3	14.4	7.7	6.5	1.2	KAO-L-PSS-01
PSS 80	100.9	57.3	13	7.7	10	1.2	
PSS 100	151.2	57.3	28.8	7.7	23.4	1.1	
PSS 120	231.8	57.3	35.4	7.7	23.4	1.1	
PSS 140	329.3	57.3	35.4	7.7	23.4	1.1	
PSO 50	10.5	57.6	7.8	1.6	4.9	9	KAO-L-PSO-01
PSO 60	10.5	57.6	8.6	1.6	6.5	9	
PSO 70	15.9	57.6	12.4	2.6	8.2	19.1	
PSO 80	15.9	57.6	12.4	2.6	10	19.1	
PSO 90	15.9	57.6	12.4	2.6	12	19.1	
PSO 100	15.9	57.6	12.4	2.6	14	19.1	
PSO 120	15.9	57.6	12.4	2.6	18.4	19.1	
PSP 140	15.1	-	22.8	-	22.8	-	KAO-L-PSP-01
PSP 160	15.1	-	34	-	34	-	
PSP 200	15.1	-	42.5	-	42.5	-	
PSPW 70	14.1	28.8	16.5	5.7	11.8	17.5	KAO-L-PSPW-01
PSPW 90	14.1	28.8	28.4	5.7	11.8	17.5	

Connector	Load-carrying capacity $N_{Rd,V}$ [kN]*		Load-carrying capacity $N_{Rd,H1}$ [kN]**		Load-carrying capacity $N_{Rd,H2}$ [kN]***		Document No.
	Timber $N_{Rk,V,w}$	Steel $N_{Rd,V,s}$	Timber $N_{Rk,H1,w}$	Steel $N_{Rd,H1,s}$	Timber $N_{Rk,H2,w}$	Steel $N_{Rd,H2,s}$	
PSPW 100	15.1	36	35.6	12.6	12.7	21.8	
PSPW 120	15.1	36	42.9	12.6	12.7	21.8	
PSPW 140	16	43.2	67.6	18	13	34.6	
PSPW 150	16	43.2	72.4	18	13	34.6	
PSPW 160	16	43.2	77.2	22.9	13	34.6	
PSPW 200	16	43.2	96.5	29	13	34.6	
PSPD 70	14.1	28.8	16.5	5.7	11.8	17.5	KAO-L-PSPD-01
PSPD 90	14.1	28.8	28.4	5.7	11.8	17.5	
PSPD 100	15.1	36	35.6	12.4	12.7	21.8	
PSPD 120	15.1	36	45.8	12.4	12.7	21.8	
PSPD 140	16	43.2	70.9	18.4	13	26.2	
PSPD 150	16	43.2	75.9	18.4	13	26.2	
PSPD 160	16	43.2	81	22.9	13	26.2	
PSPD 200	16	43.2	101.3	29	13	26.2	
PSPOD 80	14.1	28.8	20.1	0.8	11.8	21.8	KAO-L-PSPOD-01
PSPOD 90	14.1	28.8	25.4	0.8	11.8	21.8	
PSPOD 100	15.1	36	31.4	1	12.7	27.3	
PSPOD 120	15.1	36	45.2	1	12.7	27.3	
PSP DX 45	4.7	7.6	6.1	0.5	3.1	6.9	KAO-L-PSPDX-01
PSP DX 70	7.1	14.4	16.5	0.7	4.8	13.1	
PSP DX 90	7.1	14.4	28.4	0.9	5.9	13.1	
PSP DX 100	7.1	14.4	35.5	1	5.9	13.1	
PSP DX 120	7.1	14.4	42.6	1.2	5.9	13.1	
PSP DX 140	7.1	14.4	49.6	1.5	5.9	13.1	
PSP DX 150	7.6	18	64.5	1.6	6.4	16.4	

Connector	Load-carrying capacity $N_{Rd,V}$ [kN]*		Load-carrying capacity $N_{Rd,H1}$ [kN]**		Load-carrying capacity $N_{Rd,H2}$ [kN]***		Document No.
	Timber $N_{Rk,V,w}$	Steel $N_{Rd,V,s}$	Timber $N_{Rk,H1,w}$	Steel $N_{Rd,H1,s}$	Timber $N_{Rk,H2,w}$	Steel $N_{Rd,H2,s}$	
PST 75	31.9	117.5	2.5	3.7	9.1	7.1	KAO-L-PST-01
PST 80	31.9	117.5	2.5	3.7	13	7.1	
PST 150	31.9	117.5	2.5	3.7	13	7.1	
PST 160	31.9	117.5	2.5	3.7	13	7.1	
PST 200	31.9	117.5	2.5	3.7	13	7.1	
PSH 70	88.2	169.2	3.16	16.5	8.8	8.3	KAO-L-PSH-01
PSH 80	100.8	169.2	3.16	22.1	10	8.3	
PSH 90	113.4	169.2	3.16	28.4	12	8.3	
PSH 100	126	169.2	3.16	35.6	14	8.3	
PSH 120	151.2	169.2	3.16	52.3	18.4	8.3	
PSH 140	176.4	169.2	3.16	72.2	23.2	8.3	
PSH 160	201.6	169.2	3.16	95.4	28.3	8.3	
PSH 200	252	169.2	3.16	151.2	39.6	8.3	
PSZ 60	24.9	57.3	11.8	7.7	6.5	0.7	KAO-L-PSZ-01
PSZ 70	24.9	57.3	12.9	7.7	8.2	0.7	
PSZ 90	24.9	57.3	12.9	7.7	12	0.7	
PSZ 100	24.9	57.3	12.9	7.7	14	0.7	
PSZ 120	24.9	57.3	12.9	7.7	18.4	0.7	
PSZ 140	24.9	57.3	12.9	7.7	23.2	0.7	
PSW 70	88.2	57.3	11.5	7.7	13	2.1	KAO-L-PSW-01
PSW 90	151.2	57.3	21.8	7.7	22.4	2.1	
PSD 90	14.1	28.8	28.4	2.9	11.8	10.1	KAO-L-PSD-01
PSD 100	15.1	36	35.6	4.1	12.7	9	
PSD 120	15.1	36	45.3	3.5	12.7	9	
PSD 140	16	43.2	70.4	5.7	13	14.7	



Connector	Load-carrying capacity $N_{Rd,V}$ [kN]*		Load-carrying capacity $N_{Rd,H1}$ [kN]**		Load-carrying capacity $N_{Rd,H2}$ [kN]***		Document No.
	Timber $N_{Rk,V,w}$	Steel $N_{Rd,V,s}$	Timber $N_{Rk,H1,w}$	Steel $N_{Rd,H1,s}$	Timber $N_{Rk,H2,w}$	Steel $N_{Rd,H2,s}$	
PSD 160	16	43.2	80.4	5	13	12.2	
PSD 200	16	43.2	100.5	4	13	9.8	
PSC 45	14.1	36	8.1	0.2	4.2	3	KAO-L-PSCL-01
PSC 60	14.1	36	14.4	0.3	6.5	5.1	
PSC 75	16	36	22.5	0.8	9.1	10.6	
PSC 90	16	36	32.4	0.9	12	14.8	
PSOL 45	11.6	36	8.1	0.76	4	8.1	KAO-L-PSOL-01
PSOL 50	12.9	36	10	0.76	5	8.1	
PSOL 60	15.1	36	14.4	0.76	7	8.1	
PSOL 70	15.1	36	19.6	0.96	8	14.2	
PSOL 90	15.1	36	21.3	0.96	12	14.2	
PSOL 100	15.1	36	21.3	0.96	14	14.2	
PSOZ 60	24.9	112.8	11.8	1.1	6.5	10.2	KAO-L-PSOZ-01
PSOZ 70	24.9	112.8	15.9	1.1	8.2	10.2	
PSOZ 90	24.9	112.8	15.9	1.1	12	10.2	
PSOZ 100	24.9	112.8	15.9	1.1	14	10.2	
PSOZ 120	24.9	112.8	15.9	1.1	18.4	10.2	
PSOZ 140	24.9	112.8	15.9	1.1	23.2	10.2	
PUW 90	70.6	129.3	25.4	0.54	11.9	13.7	KAO-L-PUW-01
PUW 100	79	129.3	32.2	0.6	14	16.5	
PUW 120	94.1	129.3	47.3	0.72	18.4	24.9	
PUW 140	110.9	129.3	66.3	0.84	23.2	32.8	
PMF 80-100	117.1	66	-	-	-	-	KAO-L-PMF-01
PMF 80-150	117.1	66	-	-	-	-	
PMF 80-200	117.1	66	-	-	-	-	

Connector	Load-carrying capacity $N_{Rd,V}$ [kN]*		Load-carrying capacity $N_{Rd,H1}$ [kN]**		Load-carrying capacity $N_{Rd,H2}$ [kN]***		Document No.
	Timber $N_{Rk,V,w}$	Steel $N_{Rd,V,s}$	Timber $N_{Rk,H1,w}$	Steel $N_{Rd,H1,s}$	Timber $N_{Rk,H2,w}$	Steel $N_{Rd,H2,s}$	
PMF 100-100	190.2	84.6	-	-	-	-	
PMF 100-150	190.2	84.6	-	-	-	-	
PMF 100-200	190.2	84.6	-	-	-	-	

\*Load-carrying capacity  $N_{Rd,V}$  [kN] - Loading with a vertical force directed downwards

\*\*Load-carrying capacity  $N_{Rd,H1}$  [kN] - Loading with a horizontal force parallel to the bolt axis

\*\*\*Load-carrying capacity  $N_{Rd,H2}$  [kN] - Loading with a horizontal force perpendicular to the bolt axis

**Table 38** The characteristic load-carrying capacities of connectors

Connector	Timber	Load-carrying capacity $N_{Rd,V}$ [kN] <sup>1)</sup>		Load-carrying capacity $N_{Rd,H1}$ [kN] <sup>2)</sup>		Load-carrying capacity $N_{Rd,H2}$ [kN] <sup>3)</sup>		Connectors per connection	Method of determination	Document No.	Note
		Timber $N_{Rk,V,w}$	Steel $N_{Rd,V,s}$	Timber $N_{Rk,H1,w}$	Steel $N_{Rd,H1,s}$	Timber $N_{Rk,H2,w}$	Steel $N_{Rd,H2,s}$				
PSRL 0-160	C24	113.4 <sup>4)</sup>	57.3	-	-	18.6 <sup>4)</sup>	0.4	1	calculations	KAO-L-PSRL-01	1)
PSRL 0-160/400		113.4 <sup>4)</sup>	62.9	-	-	18.6 <sup>4)</sup>	0.4			KAO-L-PSRL_400-01	
PSRLT 0-160	C24	113.4 <sup>4)</sup>	57.3	-	-	18.6 <sup>4)</sup>	0.4	1	calculations	KAO-L-PSRLT-01	
PSRU 60-200/500	C24	113.4 <sup>4)</sup>	68.5	-	-	18.6 <sup>4)</sup>	0.6	1	calculations	KAO-L-PSRU 60-200_500-01	
PSRU 60-200 R500	C24	113.4 <sup>4)</sup>	59.7	-	-	18.6 <sup>4)</sup>	0.6	1	calculations	KAO-L-PSRU 60-200 R500-01	
PS 90U/500	C24	108.5	68.5	13.3	5.2	12.0	1.2	1	calculations	KAO-L-PS 500-01	
PS 100U/500		121.1	68.5	13.3	5.2	14.0	1.2				
PS 120U/500		146.3	68.5	13.3	5.2	18.4	1.2				
PS 140U/500		171.5	68.5	13.3	5.2	23.2	1.2				
PS 160U/500		196.7	68.5	13.3	5.2	28.3	1.2				
PSSOZ 60	C24	24.9	112.8	15.8	1.1	6.5	3.5	1	calculations	KAO-L-PSSOZ-01	
PSSOZ 80		33.3	150.4	21.0	1.4	10.0	3.5				
PSSOZ 100		41.6	188.0	26.3	1.8	28.0	8.3				
PSSOZ 120		49.9	225.6	31.5	2.1	35.6	8.3				
PSSOZ 140		49.9	225.6	31.5	2.1	35.6	8.3				

Connector	Timber	Load-carrying capacity $N_{Rd,V}$ [kN] <sup>1)</sup>		Load-carrying capacity $N_{Rd,H1}$ [kN] <sup>2)</sup>		Load-carrying capacity $N_{Rd,H2}$ [kN] <sup>3)</sup>		Connectors per connection	Method of determination	Document No.	Note
		Timber $N_{Rk,V,w}$	Steel $N_{Rd,V,s}$	Timber $N_{Rk,H1,w}$	Steel $N_{Rd,H1,s}$	Timber $N_{Rk,H2,w}$	Steel $N_{Rd,H2,s}$				
PSSOZ 160		49.9	225.6	31.5	2.1	35.7	8.3				
PSSZ 60	C24	24.9	57.3	15.8	7.7	6.5	0.6	1	calculations	KAO-L-PSSZ-01	
PSSZ 80		33.3	57.3	21.0	7.7	10.0	0.8				
PSSZ 100		41.6	57.3	26.3	7.7	28.0	1.0				
PSSZ 120		49.9	57.3	31.5	7.7	35.6	1.2				
PSSZ 140		49.9	57.3	31.5	7.7	35.6	1.2				
PSSZ 160		49.9	57.3	31.5	7.7	35.7	1.2				
PS 90U R500		C24	108.5	59.7	13.3	4.8	12.0				
PS 100U R500	121.1		59.7	13.3	4.8	14.0	1.2				
PS 120U R500	146.3		59.7	13.3	4.8	18.4	1.2				
PS 140U R500	171.5		59.7	13.3	4.8	23.2	1.2				
PS 160U R500	196.7		59.7	13.3	4.8	28.3	1.2				
PSW 70 R500	C24	88.2	59.7	11.5	4.8	13.0	2.1	1	calculations	KAO-L-PSW R500-01	
PSW 90 R500		151.2	59.7	21.8	4.8	22.4	2.1				
PSS 100 R500	C24	151.2	59.7	28.8	4.8	23.4	1.1	1	calculations	KAO-L-PSS R500-01	
PSS 120 R500		231.8	59.7	35.4	4.8	23.4	1.1				
PSS 140 R500		329.3	59.7	35.4	4.8	23.4	1.1				
PSS 160 R500		151.2	59.7	28.8	4.8	23.4	1.1				
PMFU 100	C24	186.9	59.7	20.5	10.0	14.0	2.2	1	calculations	KAO-L-PMFU-01	
PMFU 120		235.4	59.7	20.5	10.0	18.4	2.2				
PMFU 140		277.4	59.7	20.5	10.0	23.2	2.2				
PMFU 160		319.4	59.7	20.5	10.0	28.3	2.2				

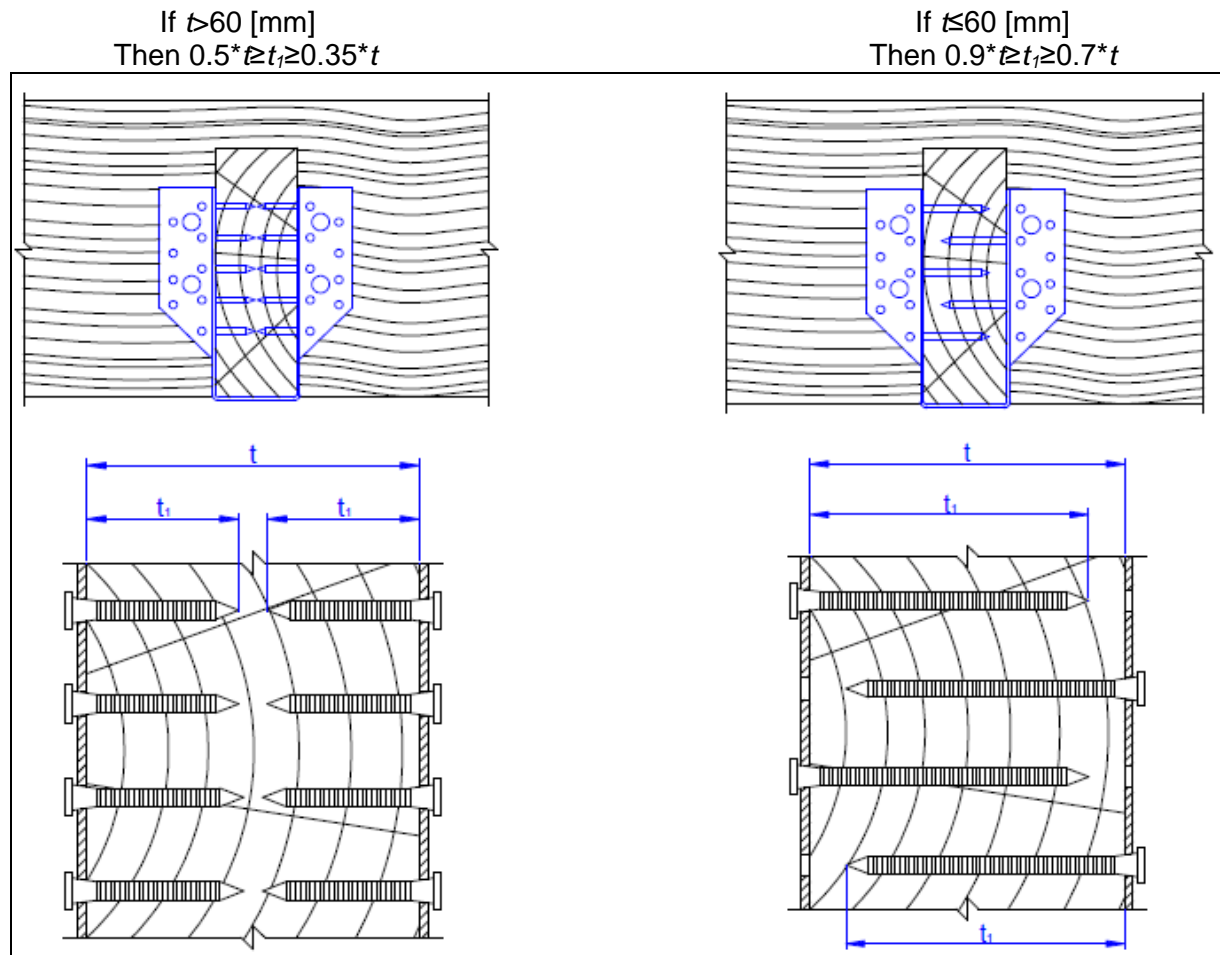
<sup>1)</sup> Load-carrying capacity  $N_{Rd,V}$  [kN] - Loading with a vertical force directed downwards

<sup>2)</sup> Load-carrying capacity  $N_{Rd,H1}$  [kN] - Loading with a horizontal force parallel to the screw axis

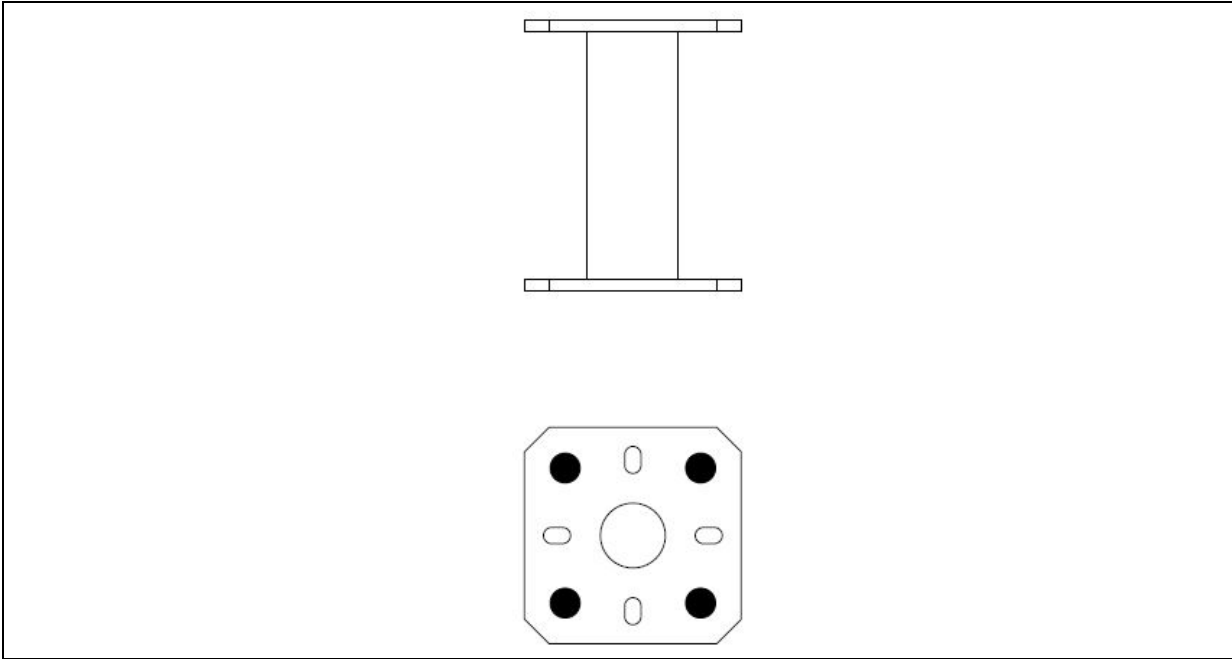
<sup>3)</sup> Load-carrying capacity  $N_{Rd,H1}$  [kN] - Loading with a horizontal force perpendicular to the screw axis

<sup>4)</sup> For timber dimensions 90x120 [mm x mm]

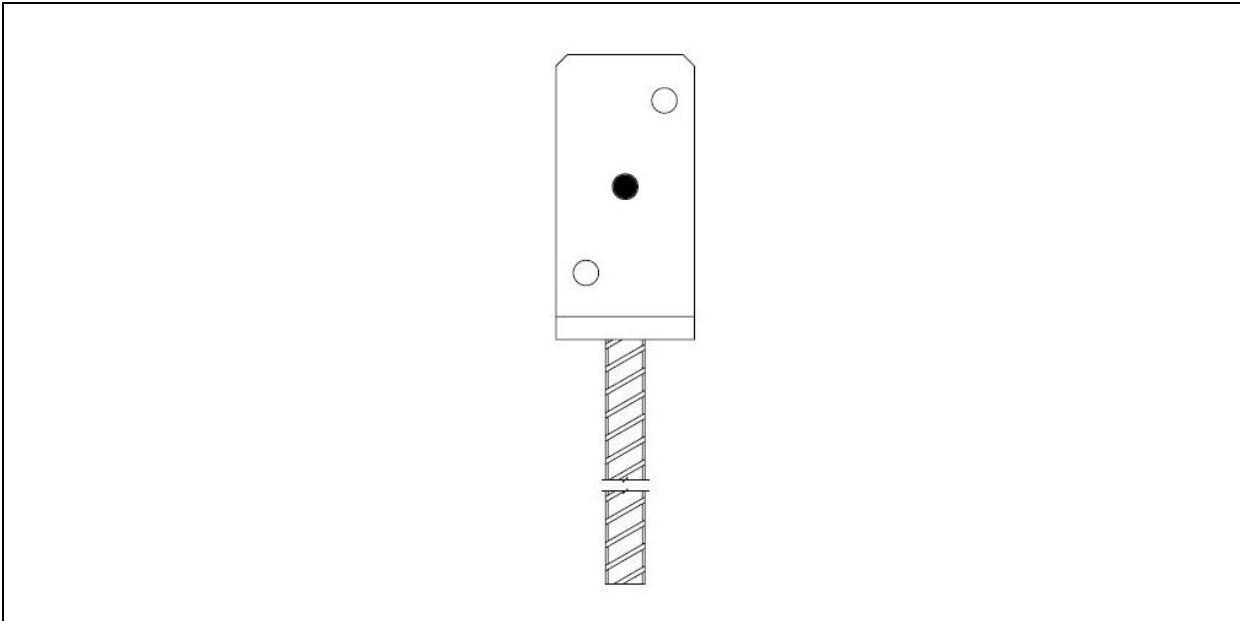
It is always necessary to put nails in the black marked holes. This is the only one proper pattern. Too many or too long nails can weaken the wood, when are quite close to edge (rule is stated below).



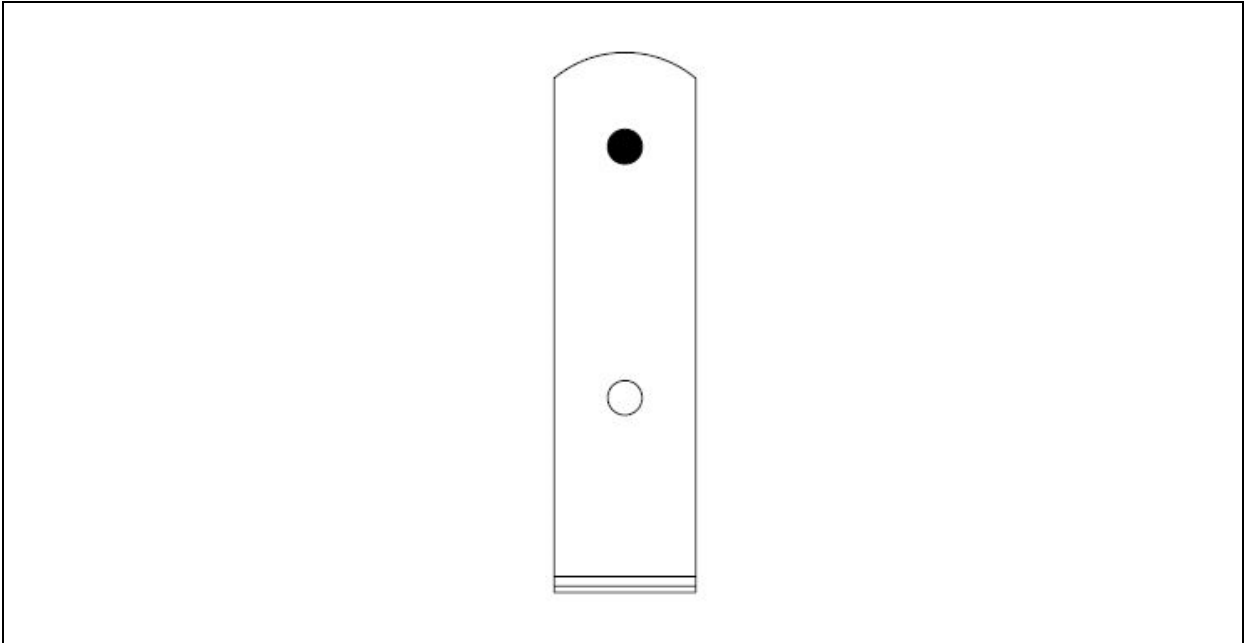
**Figure 61** Rule for placement nails



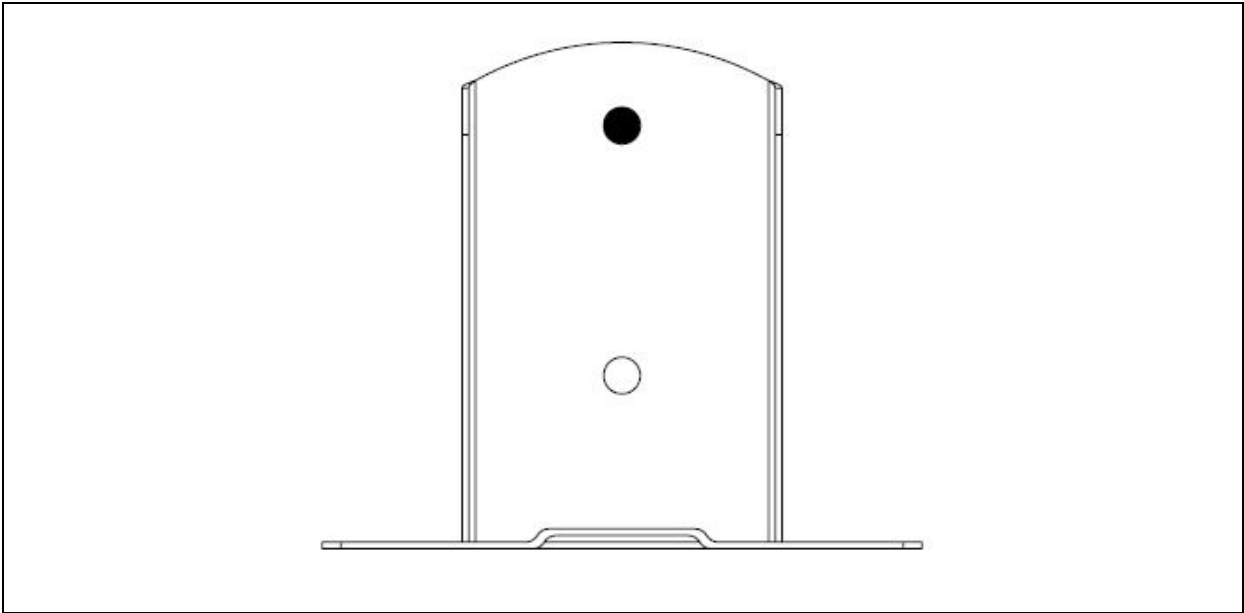
**Figure 62** Type PMF 80-100, PMF 80-150, PMF 80-200, PMF 100-100, PMF 100-150, PMF 100-200



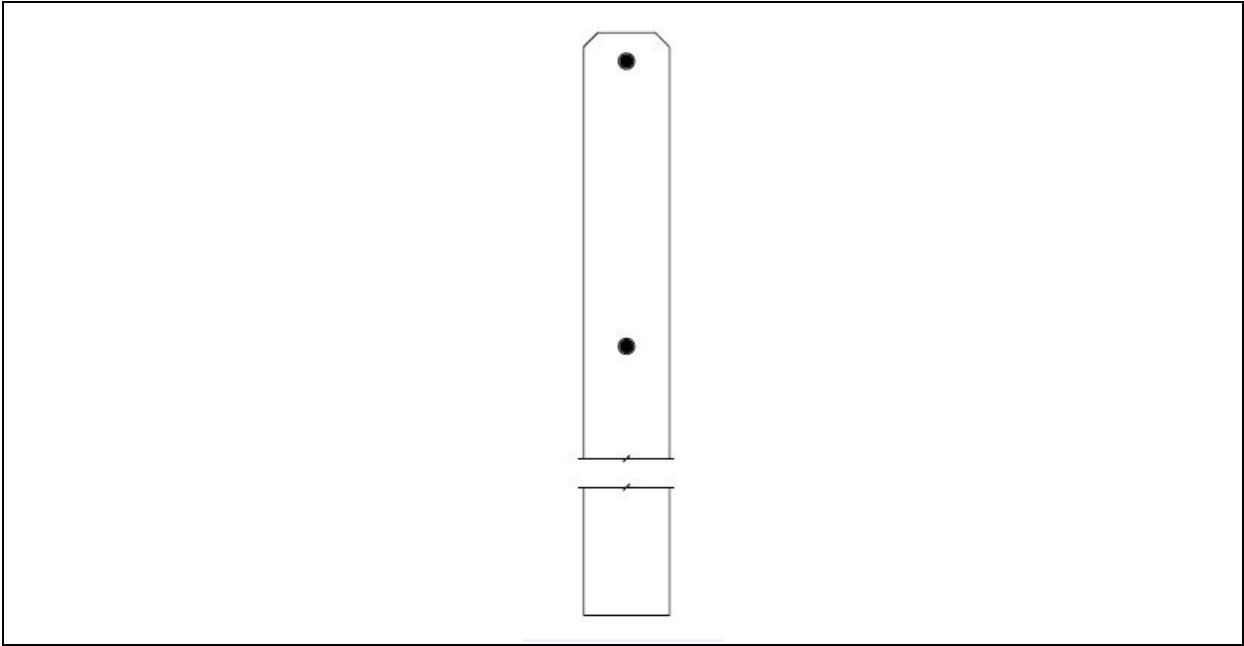
**Figure 63** Type PS 75, PS 150, PS 160



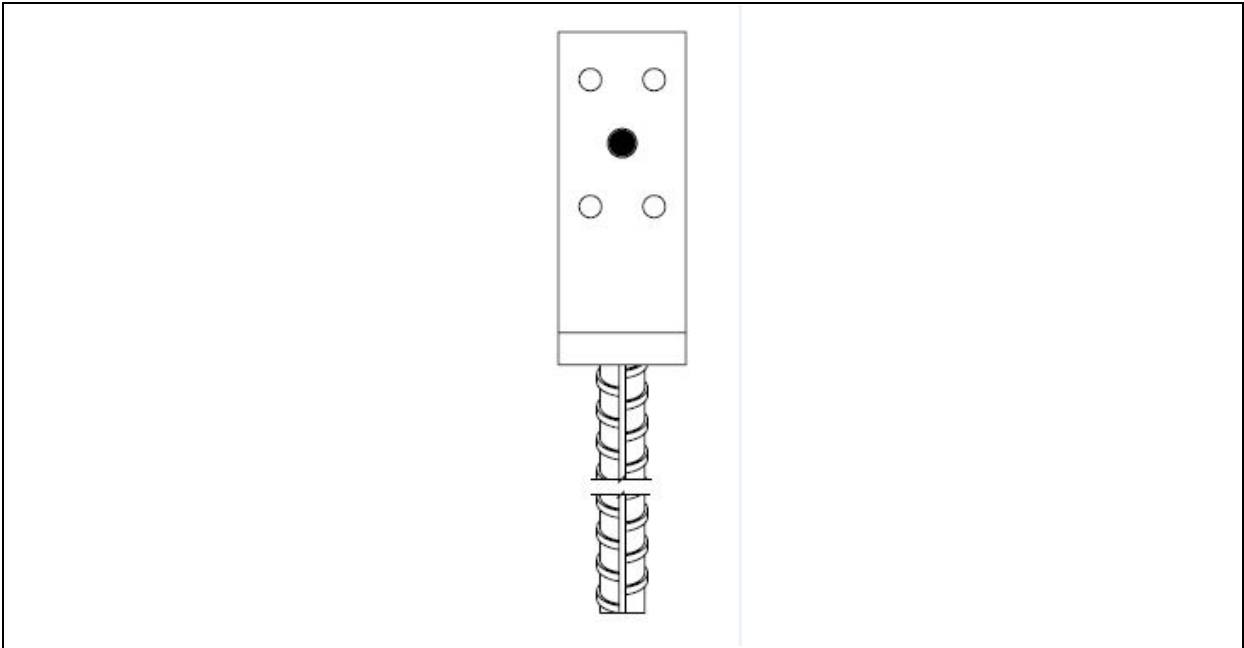
**Figure 64** Type PSC 45, PSC 60, PSC 75, PSC 90



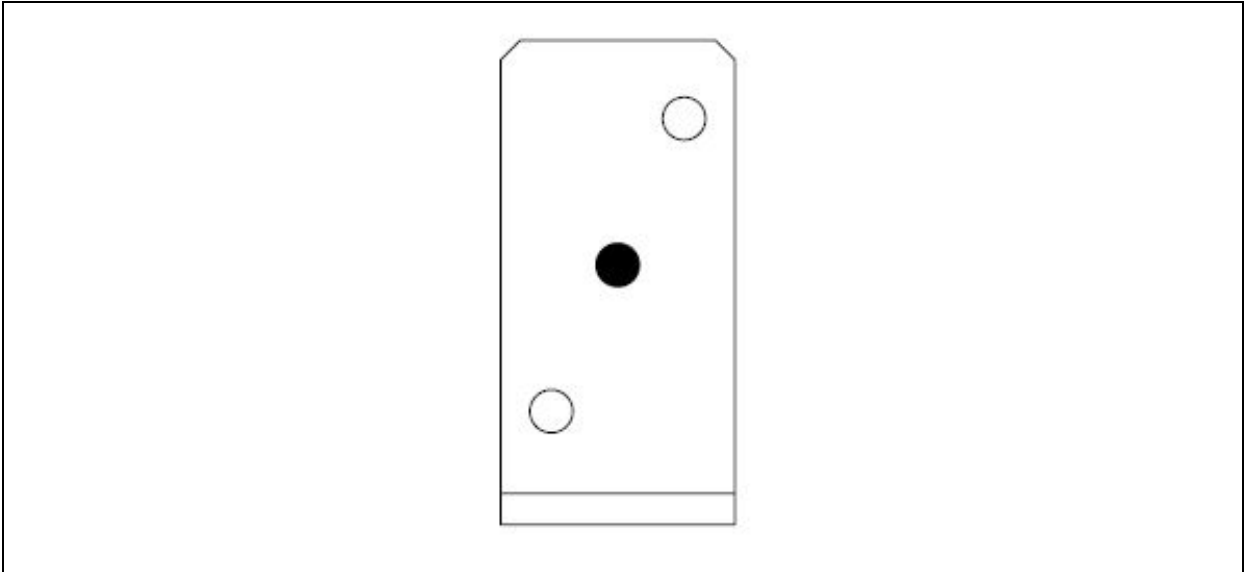
**Figure 65** Type PSD 90, PSD 100, PSD 120, PSD 140, PSD 160, PSD 200



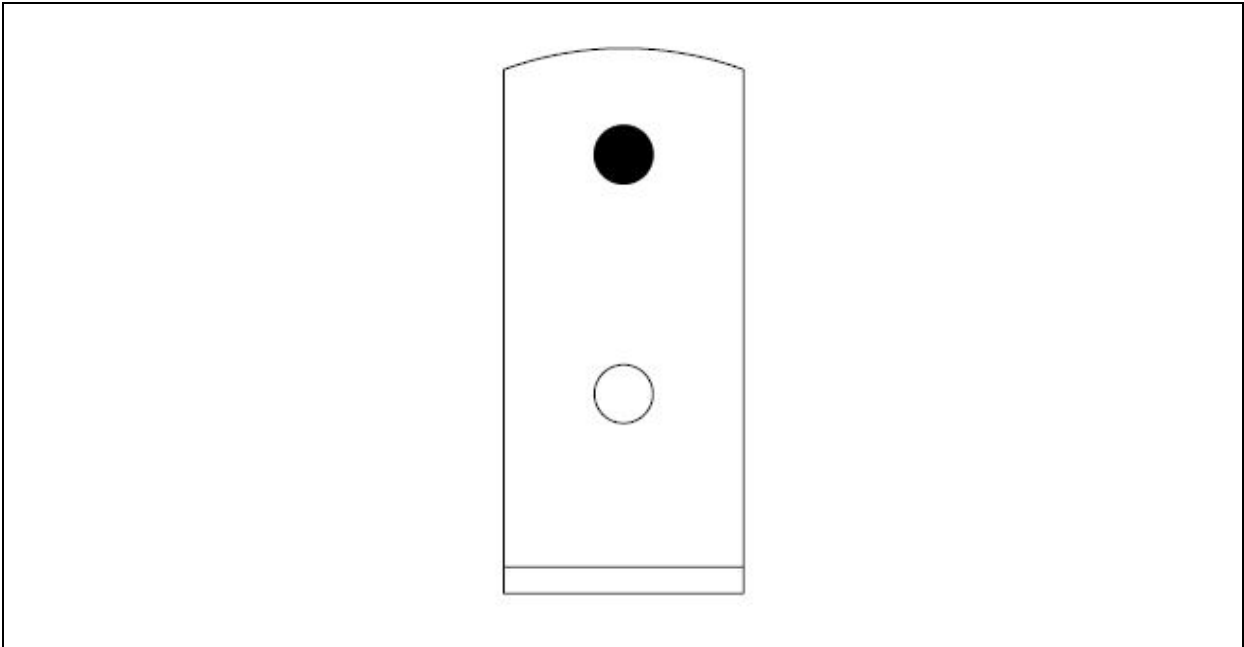
**Figure 66** Type PSH 70, PSH 80, PSH 90, PSH 100, PSH 120, PSH 140, PSH 160, PSH 200



**Figure 67** Type PSL 45U

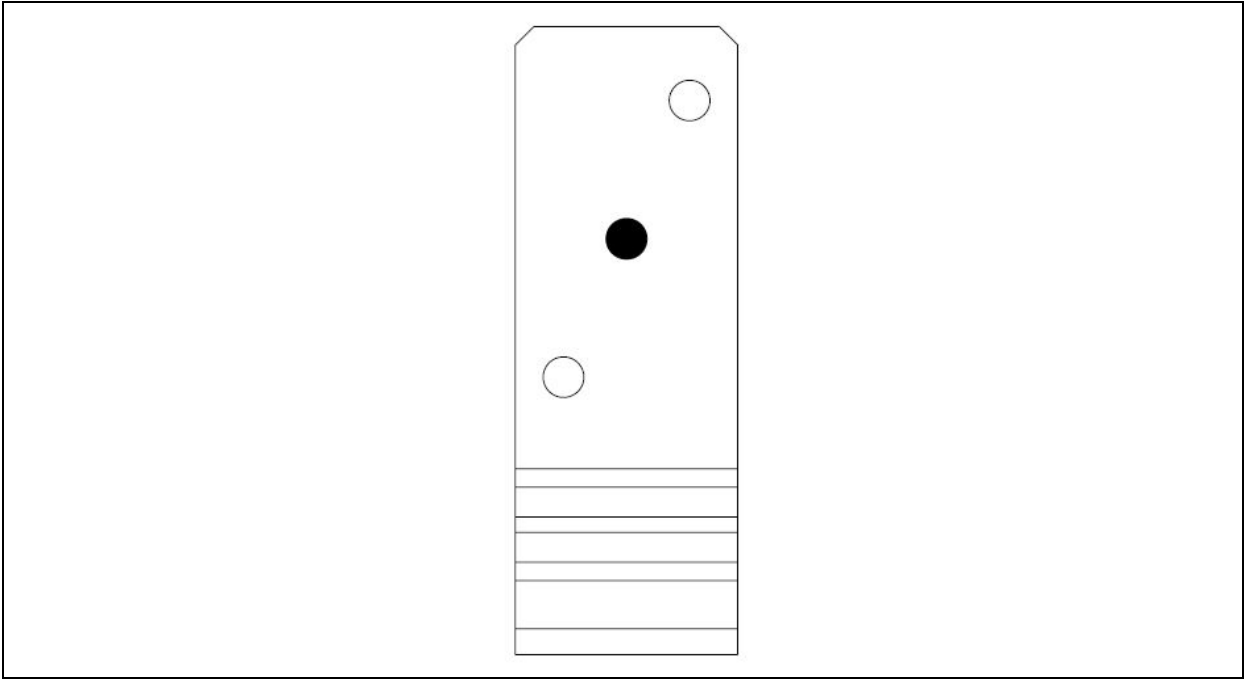


**Figure 68** PSO 50, PSO 60, PSO 70, PSO 80, PSO 90, PSO 100, PSO 120

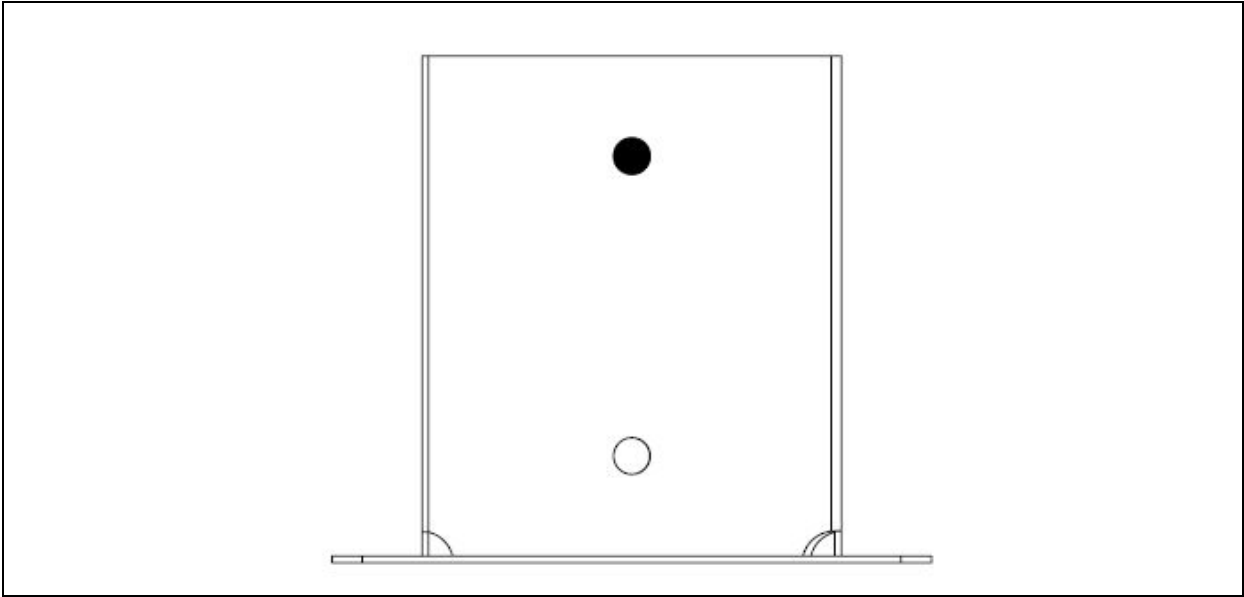


**Figure 69** Type PSOL 45, PSOL 50, PSOL 60, PSOL 70, PSOL 90, PSOL 100

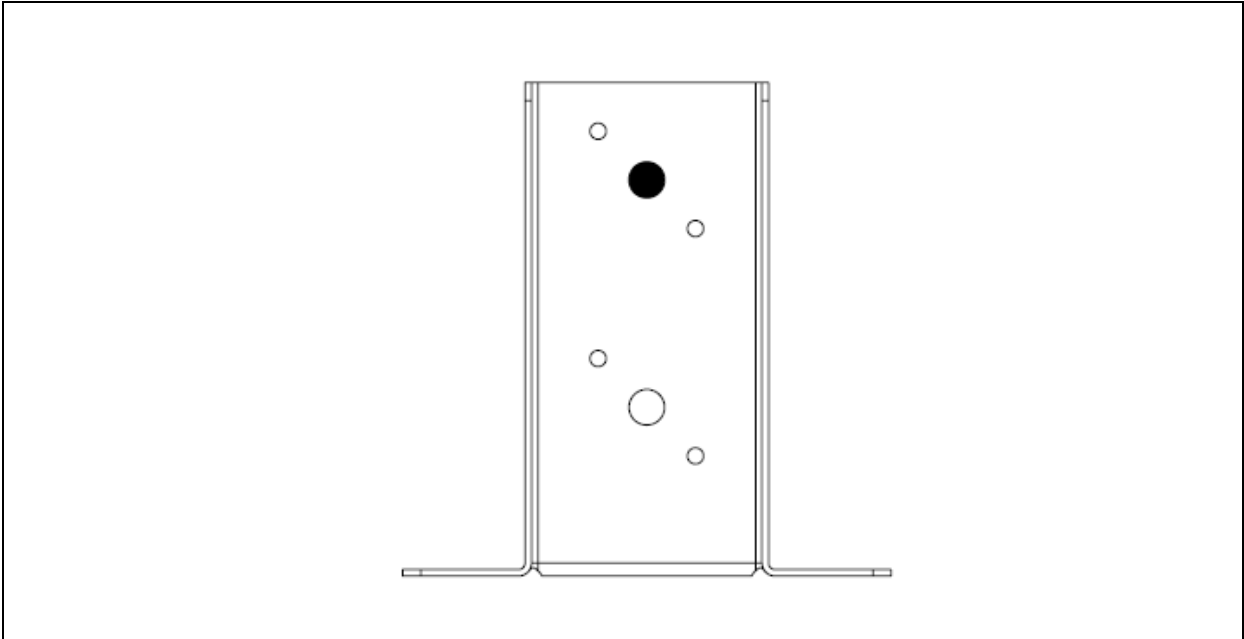




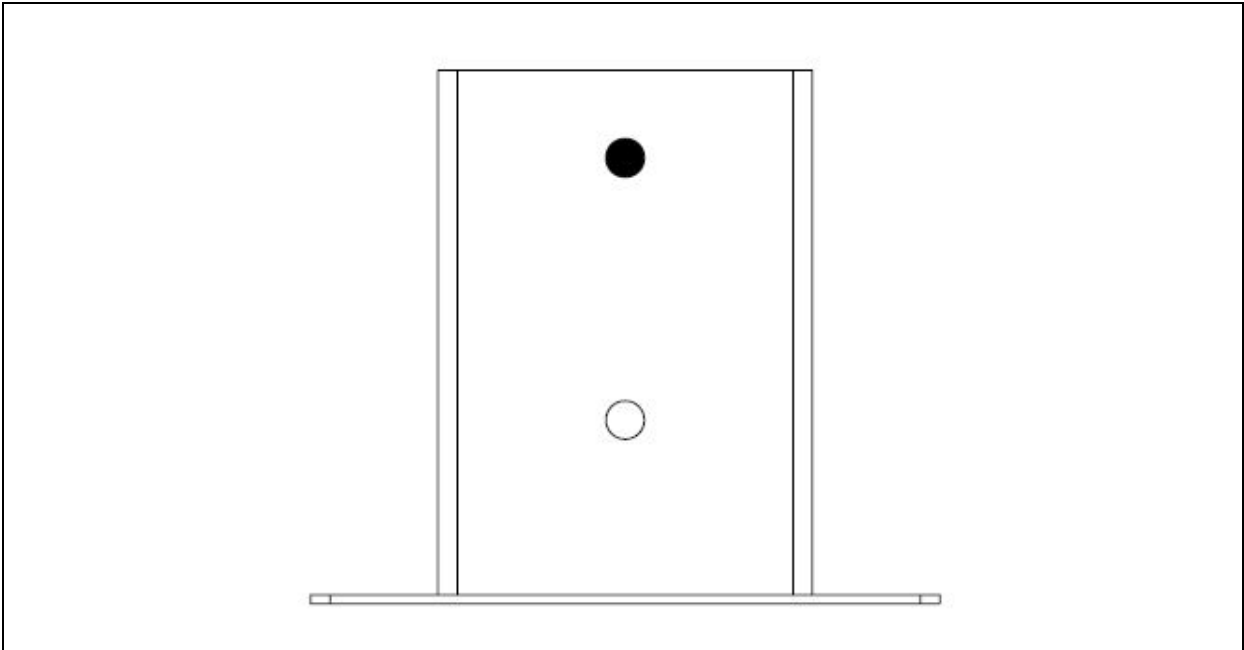
**Figure 70** Type PSOZ 60, PSOZ 70, PSOZ 90, PSOZ 100, PSOZ 120, PSOZ 140



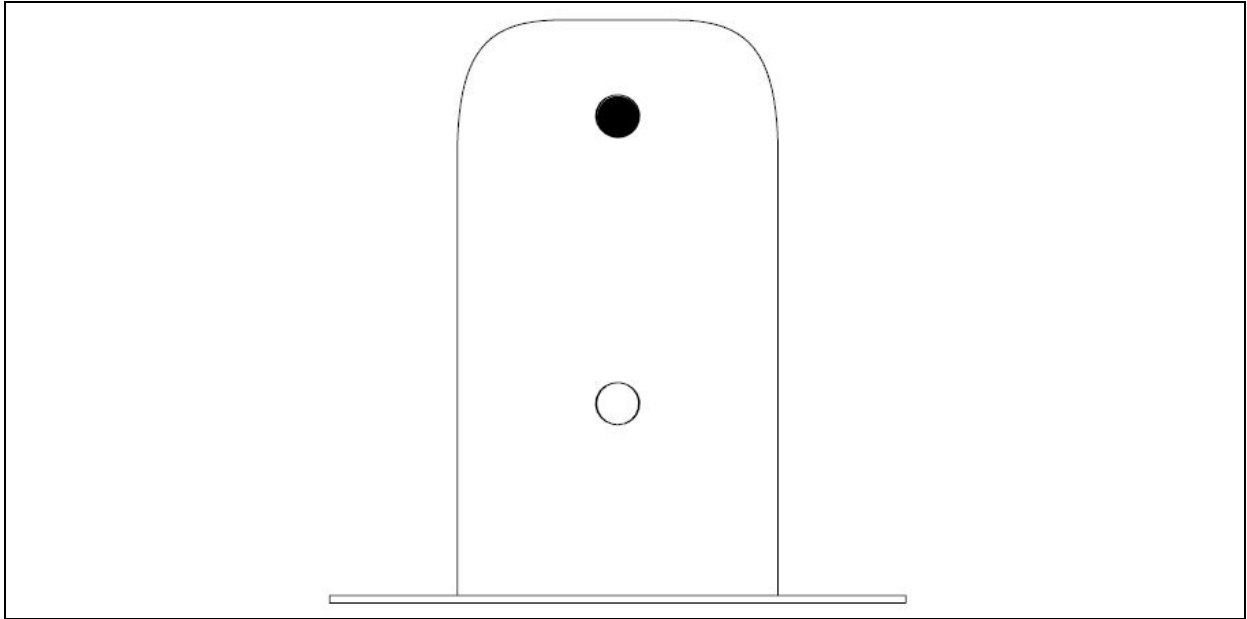
**Figure 71** Type PSP 140, PSP 160, PSP 200



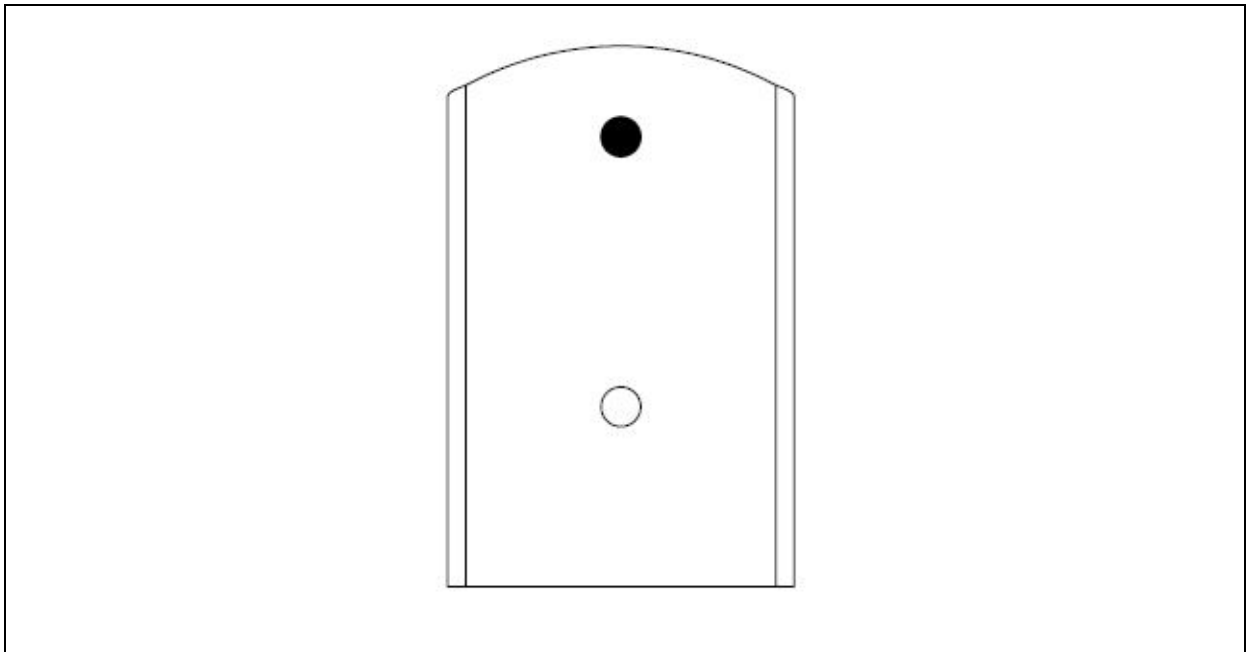
**Figure 72** Type PSPDX 45, PSPDX 70, PSPDX 90, PSPDX 100, PSPDX 120, PSPDX 140, PSPDX 150



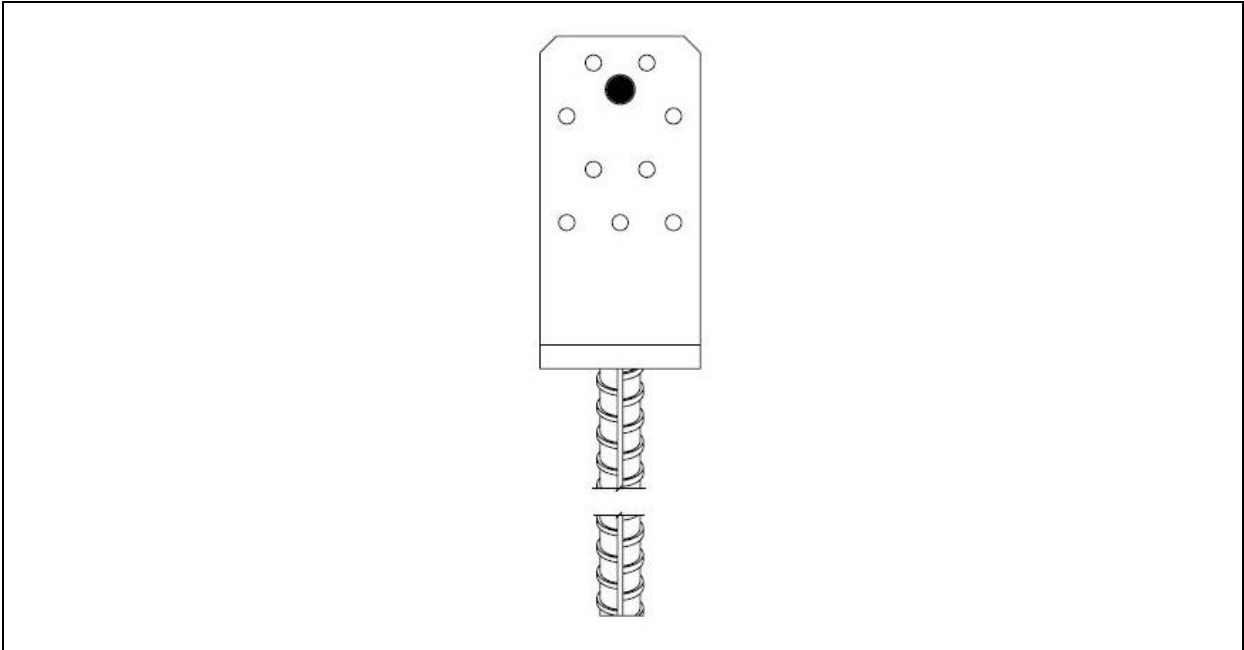
**Figure 73** Type PSPD 70, PSPD 90, PSPD 100, PSPD 120, PSPD 140, PSPD 150, PSPD 160, PSPD 200



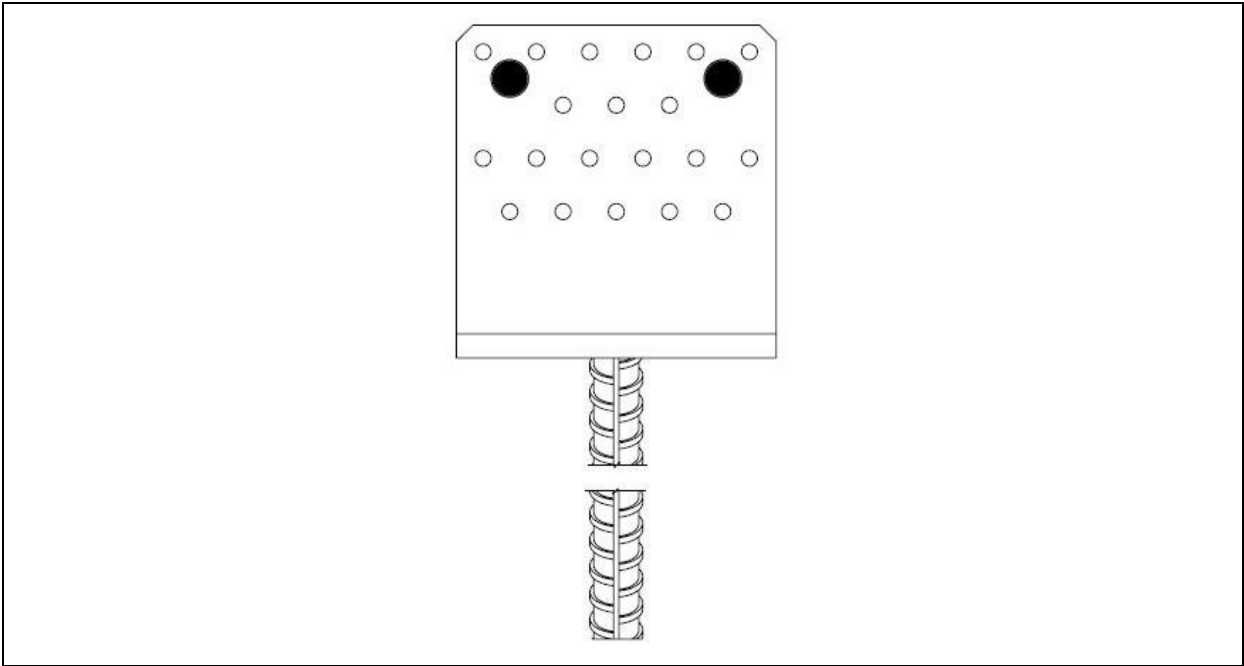
**Figure 74** Type PSPOD 80, PSPOD 90, PSPOD 100, PSPOD 120



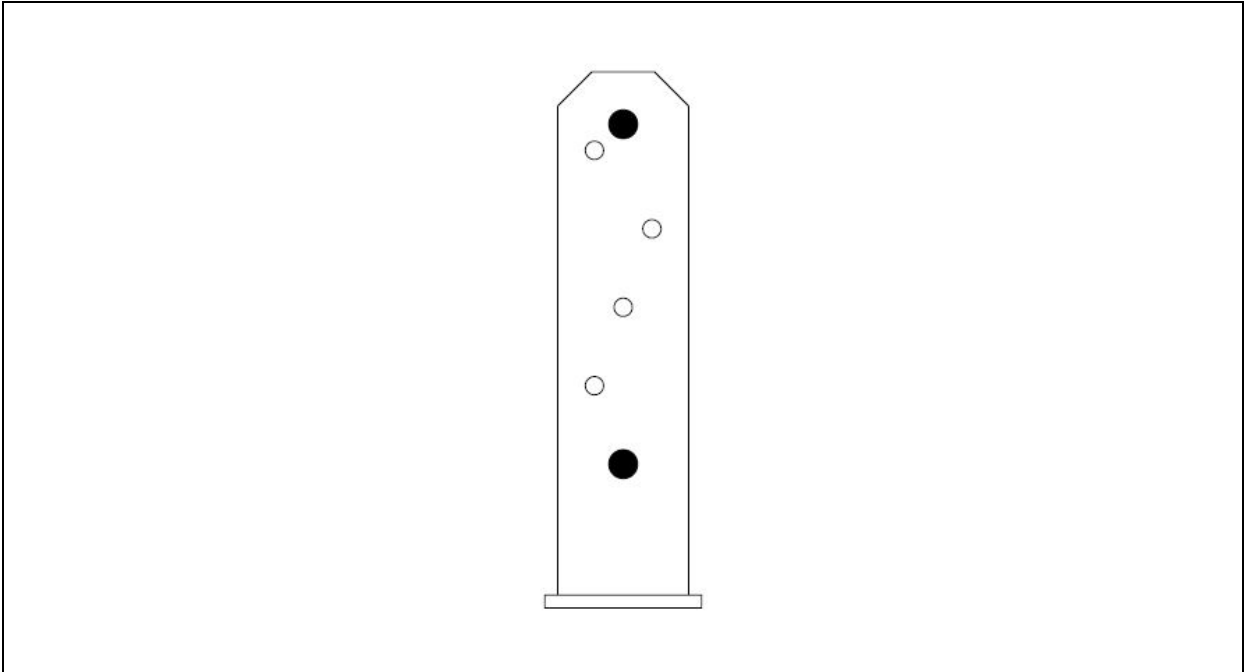
**Figure 75** Type PSPW 70, PSPW 90, PSPW 100, PSPW 120, PSPW 140, PSPW 150, PSPW 160, PSPW 200



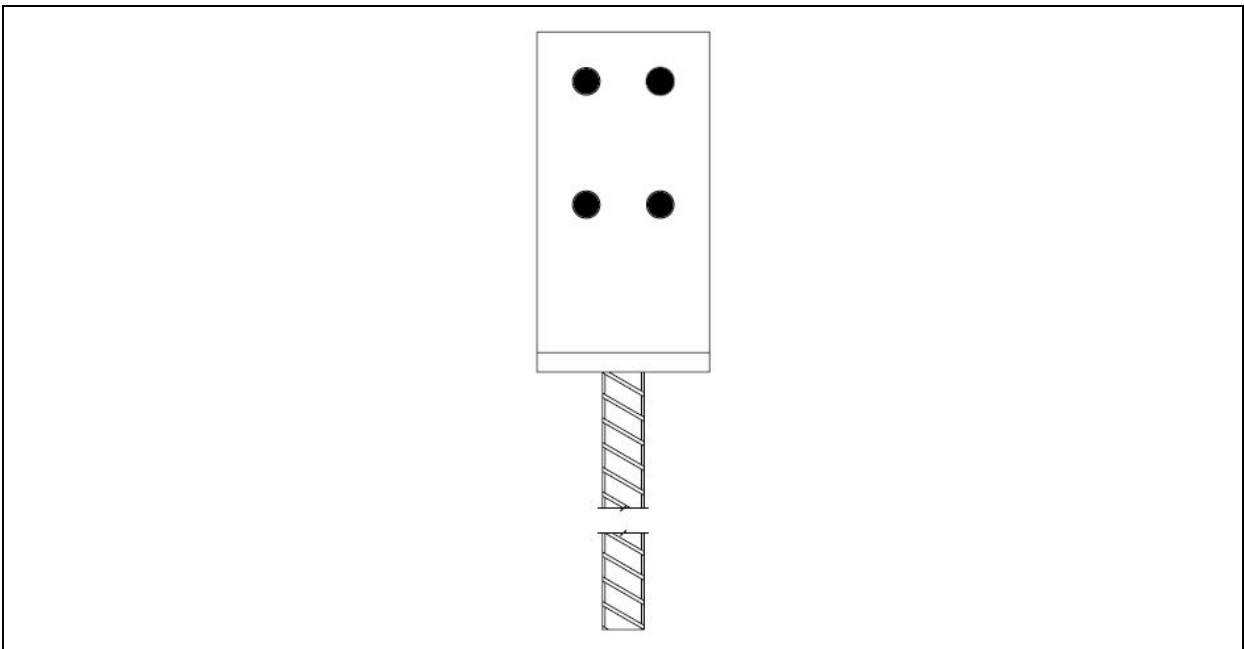
**Figure 76** Type PSS 60, PSS 80



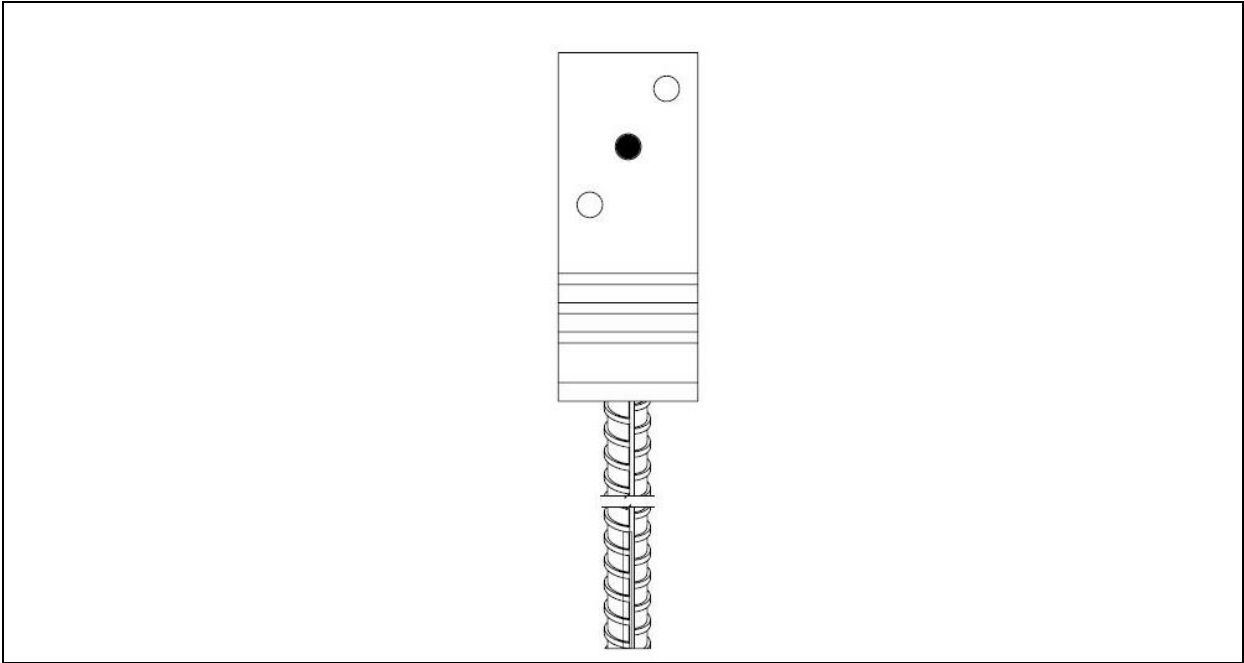
**Figure 77** Type PSS 100, PSS 120, PSS 140



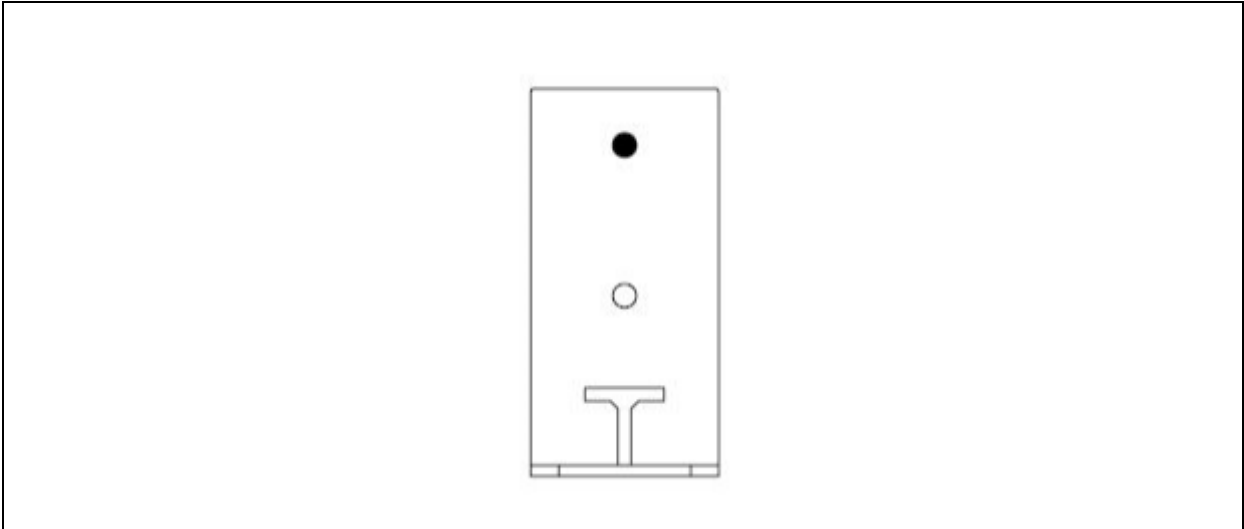
**Figure 78** Type PST 75, PST 80, PST 150, PST 160, PST 200



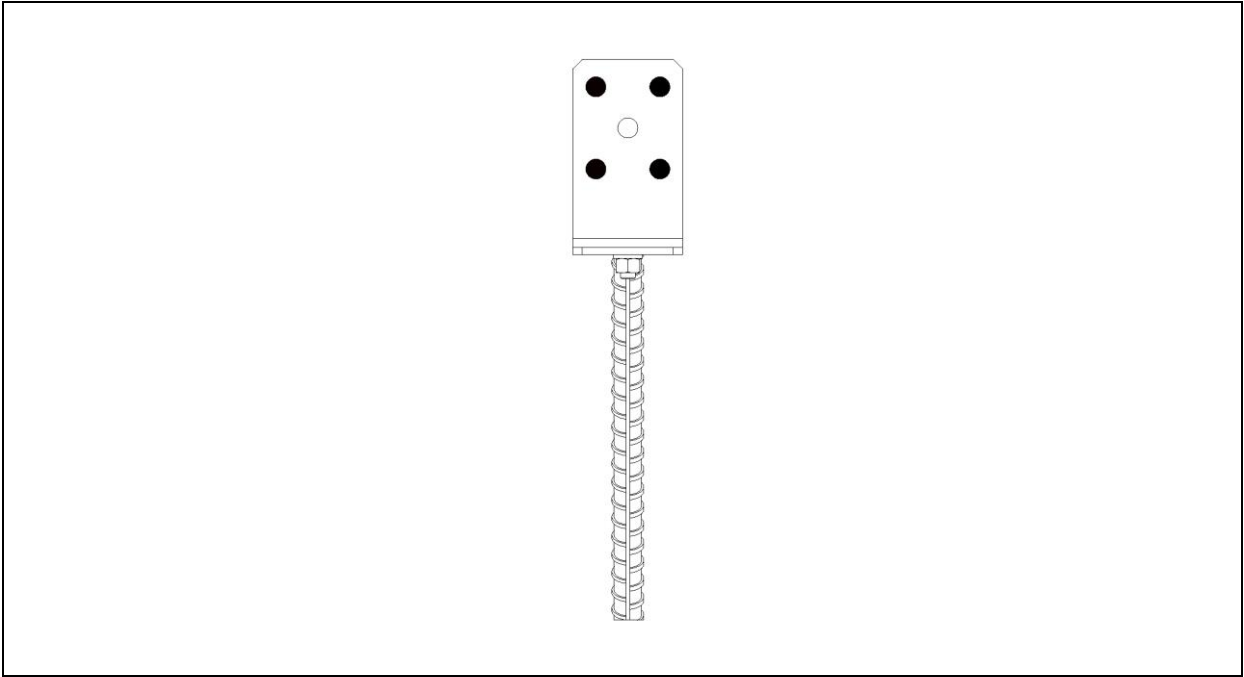
**Figure 79** Type PSW 70, PSW 90



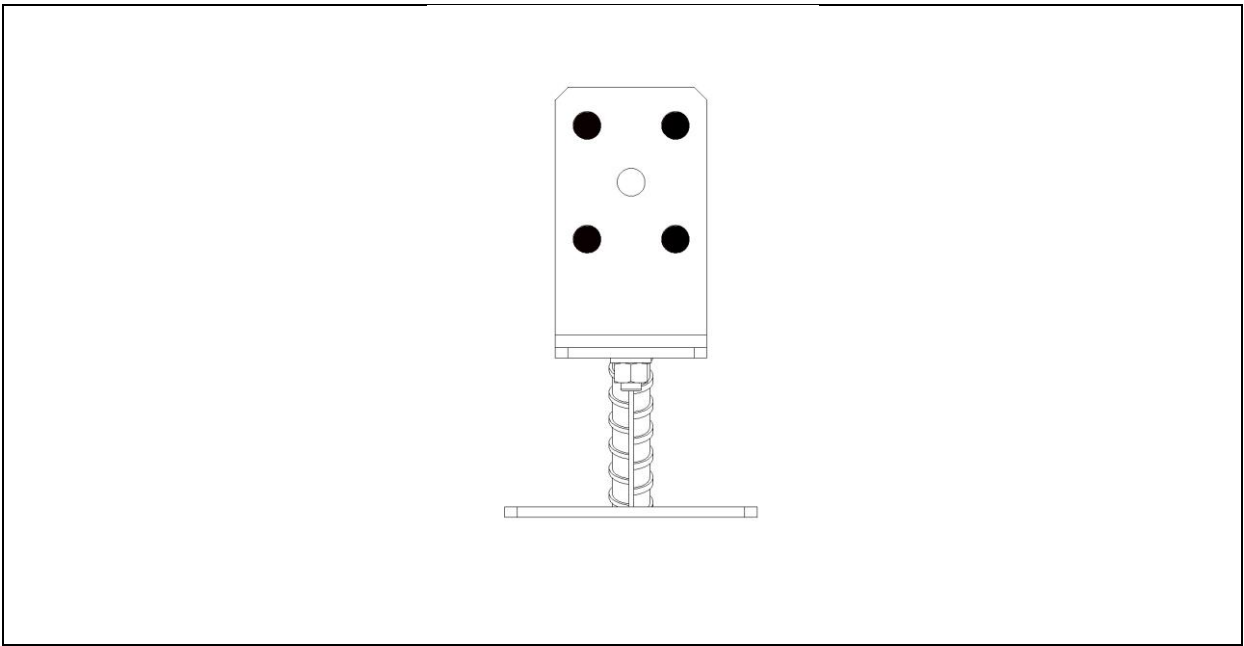
**Figure 80** Type PSZ 60, PSZ 70, PSZ 90, PSZ 100, PSZ 120, PSZ 140



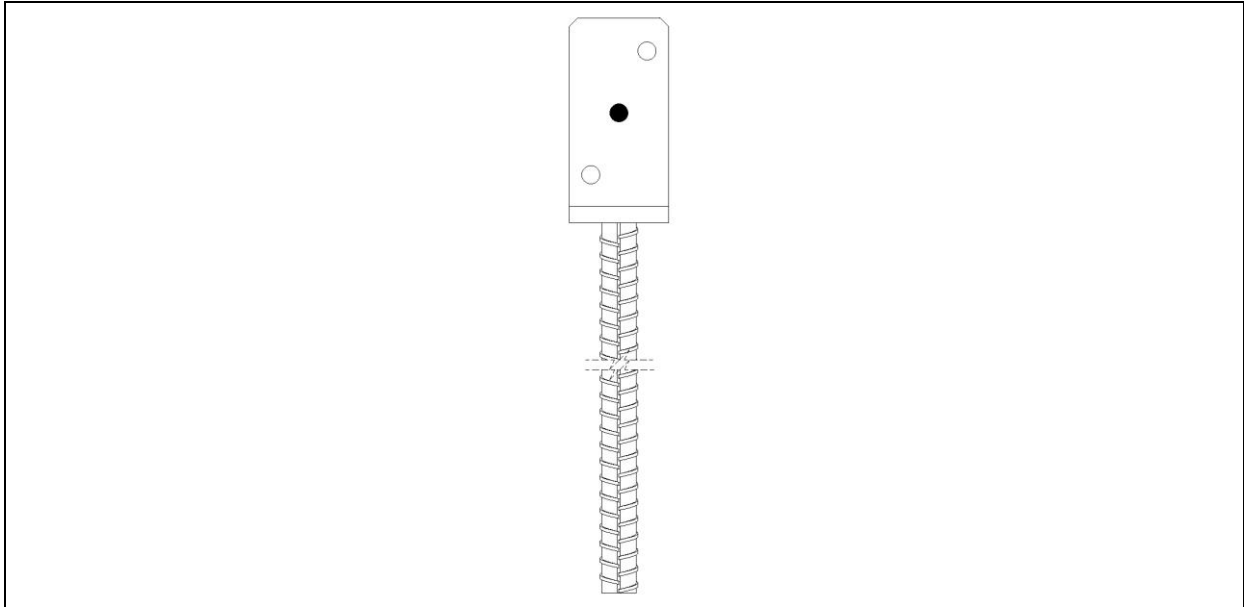
**Figure 81** Type PUW 90, PUW 100, PUW 120, PUW 140



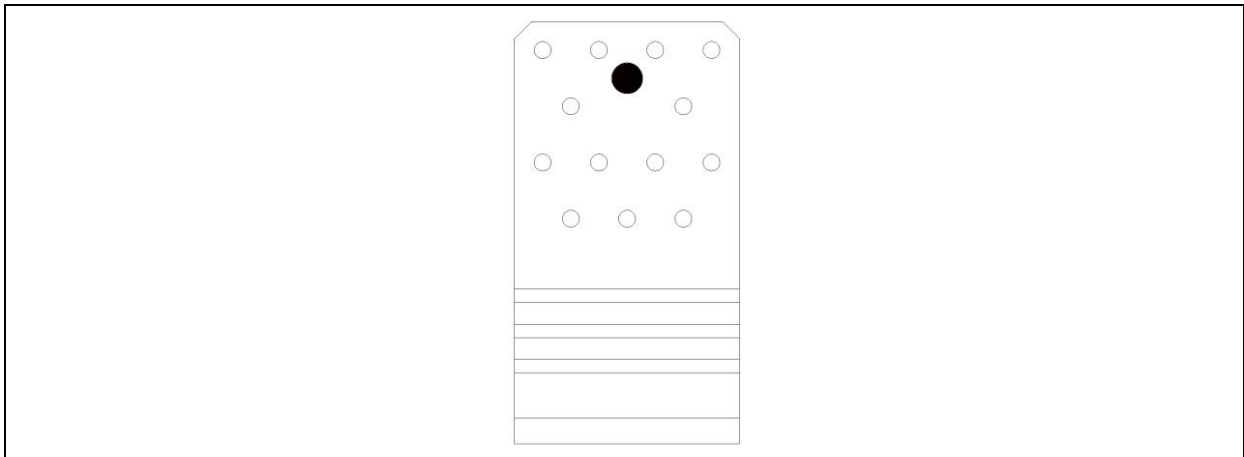
**Figure 82** PSRL 0-160, PSRL 0-160/400



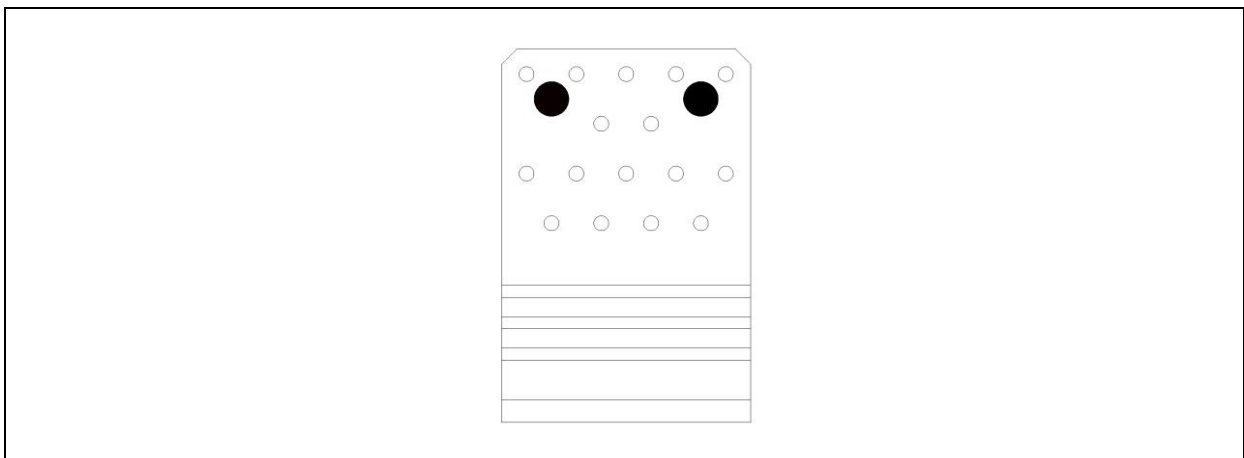
**Figure 83** PSRLT 0-160



**Figure 84** PS 90U/500, PS 100U/500, PS 120U/500, PS 140U/500, PS 160U/500  
 PS 90U R500, PS 100U R500, PS 120U R500, PS 140U R500, PS 160U R500

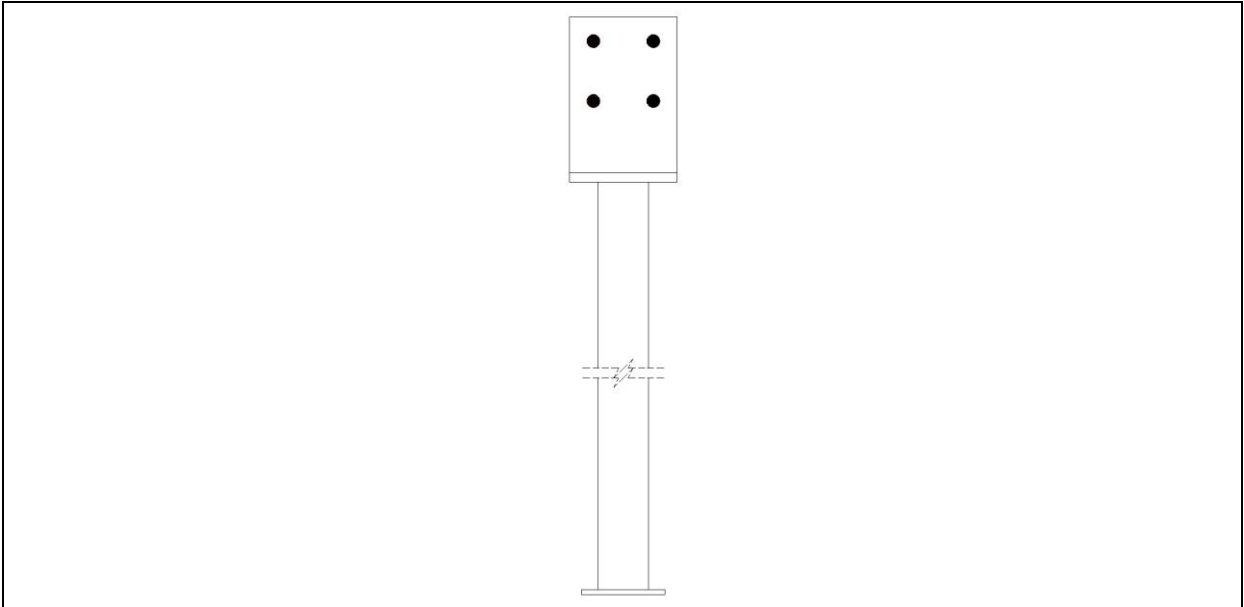


**Figure 85** PSSZ 60, PSSZ 80  
 PSSOZ 60, PSSOZ 80

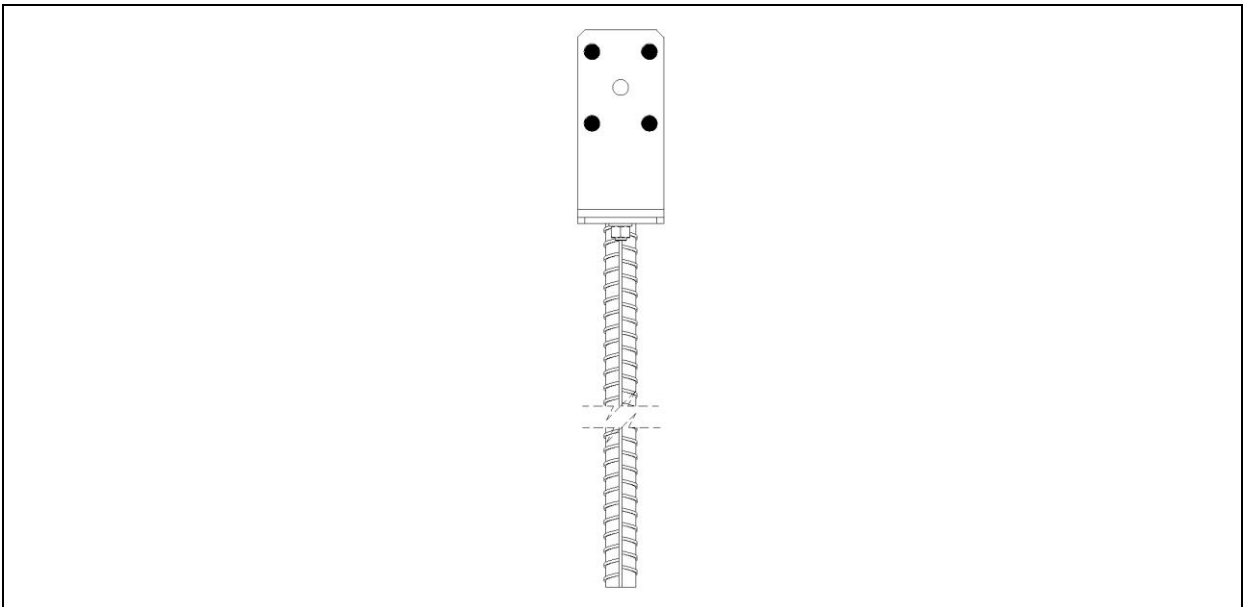


**Figure 86** PSSZ 100, PSSZ 120, PSSZ 140, PSSZ 160, PSSOZ 100, PSSOZ 120,  
 PSSOZ 140, PSSOZ 160, PSS 100 R500, PSS 120 R500, PSS 140 R500, PSS 160 R500

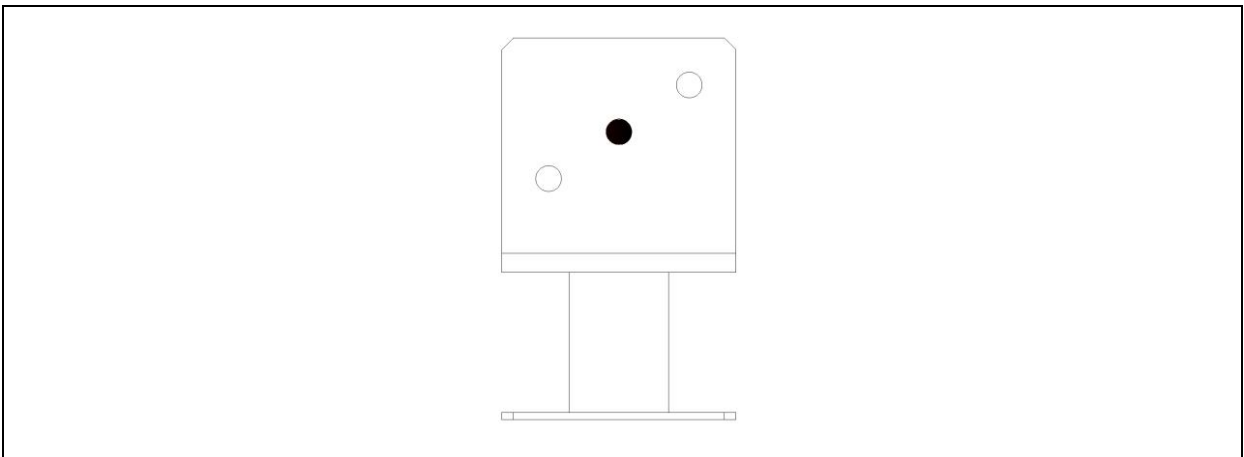




**Figure 87** PSW 70, PSW 90



**Figure 88** PSRU 60-200/500, PSRU 60-200 R500



**Figure 89** PMFU 100, PMFU 120, PMFU 140, PMFU 160

<b>THREE-DIMENSIONAL NAILING PLATES</b>	<b>ANNEX 5</b> ETA 20/1044
<b>SPECIFICATION OF CONNECTION ELEMENTS</b>	

**Table 39** Specification of connection elements

Connector	Dowel type fasteners	Fasteners per detail [pcs.]	Fasteners per connection [pcs.]
PS 75U	Screw M10x90-5.8+Washer M10	1	1
PS 150U	Screw M10x180-5.8+Washer M10	1	1
PS 160U	Screw M10x180-5.8+Washer M10	1	1
PSL 45U	Screw M8x60-5.8+Washer M8	1	1
PSS 60	Screw M10x80-5.8+Washer M10	1	1
PSS 80	Screw M10x100-5.8+Washer M10	1	1
PSS 100	Screw M10x120-5.8+Washer M10	2	2
PSS 120	Screw M10x140-5.8+Washer M10	2	2
PSS 140	Screw M10x160-5.8+Washer M10	2	2
PSO 50	Screw M10x60-5.8+Washer M10	1	1
PSO 60	Screw M10x80-5.8+Washer M10	1	1
PSO 70	Screw M10x90-5.8+Washer M10	1	1
PSO 80	Screw M10x100-5.8+Washer M10	1	1
PSO 90	Screw M10x110-5.8+Washer M10	1	1
PSO 100	Screw M10x120-5.8+Washer M10	1	1
PSO 120	Screw M10x140-5.8+Washer M10	1	1
PSP 140	Screw M10x160-5.8+Washer M10	1	1
PSP 160	Screw M10x180-5.8+Washer M10	1	1
PSP 200	Screw M10x220-5.8+Washer M10	1	1
PSPW 70	Screw M10x90-5.8+Washer M10	1	1
PSPW 90	Screw M10x110-5.8+Washer M10	1	1
PSPW 100	Screw M10x120-5.8+Washer M10	1	1
PSPW 120	Screw M10x140-5.8+Washer M10	1	1
PSPW 140	Screw M10x160-5.8+Washer M10	1	1
PSPW 150	Screw M10x180-5.8+Washer M10	1	1
PSPW 160	Screw M10x180-5.8+Washer M10	1	1
PSPW 200	Screw M10x220-5.8+Washer M10	1	1
PSPD 70	Screw M10x90-5.8+Washer M10	1	1
PSPD 90	Screw M10x110-5.8+Washer M10	1	1
PSPD 100	Screw M10x120-5.8+Washer M10	1	1
PSPD 120	Screw M10x140-5.8+Washer M10	1	1
PSPD 140	Screw M10x160-5.8+Washer M10	1	1
PSPD 150	Screw M10x180-5.8+Washer M10	1	1
PSPD 160	Screw M10x180-5.8+Washer M10	1	1
PSPD 200	Screw M10x220-5.8+Washer M10	1	1
PSPOD 80	Screw M10x100-5.8+Washer M10	1	1
PSPOD 90	Screw M10x110-5.8+Washer M10	1	1

Connector	Dowel type fasteners	Fasteners per detail [pcs.]	Fasteners per connection [pcs.]
PSPD 100	Screw M10x120-5.8+Washer M10	1	1
PSPD 120	Screw M10x140-5.8+Washer M10	1	1
PSP DX 45	Screw M10x60-5.8+Washer M10	1	1
PSP DX 70	Screw M10x90-5.8+Washer M10	1	1
PSP DX 90	Screw M10x110-5.8+Washer M10	1	1
PSP DX 100	Screw M10x120-5.8+Washer M10	1	1
PSP DX 120	Screw M10x140-5.8+Washer M10	1	1
PSP DX 140	Screw M10x160-5.8+Washer M10	1	1
PSP DX 150	Screw M10x180-5.8+Washer M10	1	1
PST 75	Screw M10x90-5.8+Washer M10	2	2
PST 80	Screw M10x100-5.8+Washer M10	2	2
PST 150	Screw M10x180-5.8+Washer M10	2	2
PST 160	Screw M10x180-5.8+Washer M10	2	2
PST 200	Screw M10x220-5.8+Washer M10	2	2
PSH 70	Screw M10x90-5.8+Washer M10	2	2
PSH 80	Screw M10x100-5.8+Washer M10	2	2
PSH 90	Screw M10x110-5.8+Washer M10	2	2
PSH 100	Screw M10x120-5.8+Washer M10	2	2
PSH 120	Screw M10x140-5.8+Washer M10	2	2
PSH 140	Screw M10x160-5.8+Washer M10	2	2
PSH 160	Screw M10x180-5.8+Washer M10	2	2
PSH 200	Screw M10x220-5.8+Washer M10	2	2
PSZ 60	Screw M10x80-5.8+Washer M10	1	1
PSZ 70	Screw M10x90-5.8+Washer M10	1	1
PSZ 90	Screw M10x110-5.8+Washer M10	1	1
PSZ 100	Screw M10x120-5.8+Washer M10	1	1
PSZ 120	Screw M10x140-5.8+Washer M10	1	1
PSZ 140	Screw M10x160-5.8+Washer M10	1	1
PSW 70	Screw M10x90-5.8+Washer M10	4	4
PSW 90	Screw M10x110-5.8+Washer M10	4	4
PSD 90	Screw M10x110-5.8+Washer M10	1	1
PSD 100	Screw M10x120-5.8+Washer M10	1	1
PSD 120	Screw M10x140-5.8+Washer M10	1	1
PSD 140	Screw M10x160-5.8+Washer M10	1	1
PSD 160	Screw M10x180-5.8+Washer M10	1	1
PSD 200	Screw M10x220-5.8+Washer M10	1	1
PSC 45	Screw M10x60-5.8+Washer M10	1	1
PSC 60	Screw M10x80-5.8+Washer M10	1	1
PSC 75	Screw M10x90-5.8+Washer M10	1	1
PSC 90	Screw M10x110-5.8+Washer M10	1	1

Connector	Dowel type fasteners	Fasteners per detail [pcs.]	Fasteners per connection [pcs.]
PSOL 45	Screw M10x60-5.8+Washer M10	1	1
PSOL 50	Screw M10x80-5.8+Washer M10	1	1
PSOL 60	Screw M10x80-5.8+Washer M10	1	1
PSOL 70	Screw M10x90-5.8+Washer M10	1	1
PSOL 90	Screw M10x110-5.8+Washer M10	1	1
PSOL 100	Screw M10x120-5.8+Washer M10	1	1
PSOZ 60	Screw M10x80-5.8+Washer M10	1	1
PSOZ 70	Screw M10x90-5.8+Washer M10	1	1
PSOZ 90	Screw M10x110-5.8+Washer M10	1	1
PSOZ 100	Screw M10x120-5.8+Washer M10	1	1
PSOZ 120	Screw M10x140-5.8+Washer M10	1	1
PSOZ 140	Screw M10x160-5.8+Washer M10	1	1
PUW 90	Screw M12x110-5.8+Washer M10	1	1
PUW 100	Screw M12x120-5.8+Washer M10	1	1
PUW 120	Screw M12x140-5.8+Washer M10	1	1
PUW 140	Screw M12x160-5.8+Washer M10	1	1
PMF 80-100	Anchor Ø4,0x50	4	4
PMF 80-150	Anchor Ø4,0x50	4	4
PMF 80-200	Anchor Ø4,0x50	4	4
PMF 100-100	Anchor Ø4,0x50	4	4
PMF 100-150	Anchor Ø4,0x50	4	4
PMF 100-200	Anchor Ø4,0x50	4	4
PSRL 0-160	Screw M10x110 - cl.5.8 + Washer M10	4	4
PSRL 0-160/400	Screw M10x110 - cl.5.8 + Washer M10	4	4
PSRLT 0-160	Screw M10x110 - cl.5.8 + Washer M10	4	4
PS 90U/500	Screw M10x110 - cl.5.8 + Washer M10	1	1
PS 100U/500	Screw M10x120 - cl.5.8 + Washer M10	1	1
PS 120U/500	Screw M10x140 - cl.5.8 + Washer M10	1	1
PS 140U/500	Screw M10x160 - cl.5.8 + Washer M10	1	1
PS 160U/500	Screw M10x180 - cl.5.8 + Washer M10	1	1
PSSZ 60	Screw M10x80 - cl.5.8 + Washer M10	1	1
PSSZ 80	Screw M10x100 - cl.5.8 + Washer M10	1	1
PSSZ 100	Screw M10x120 - cl.5.8 + Washer M10	2	2
PSSZ 120	Screw M10x140 - cl.5.8 + Washer M10	2	2
PSSZ 140	Screw M10x160 - cl.5.8 + Washer M10	2	2
PSSZ 160	Screw M10x180 - cl.5.8 + Washer M10	2	2
PSRU 60-200/500	Screw M10x110 - cl.5.8 + Washer M10	4	4
PSSOZ 60	Screw M10x80 - cl.5.8 + Washer M10	1	1
PSSOZ 80	Screw M10x100 - cl.5.8 + Washer M10	1	1
PSSOZ 100	Screw M10x120 - cl.5.8 + Washer M10	2	2
PSSOZ 120	Screw M10x140 - cl.5.8 + Washer M10	2	2
PSSOZ 140	Screw M10x160 - cl.5.8 + Washer M10	2	2
PSSOZ 160	Screw M10x180 - cl.5.8 + Washer M10	2	2
PS 90U R500	Screw M10x110 - cl.5.8 + Washer M10	1	1
PS 100U R500	Screw M10x120 - cl.5.8 + Washer M10	1	1

Connector	Dowel type fasteners	Fasteners per detail [pcs.]	Fasteners per connection [pcs.]
PS 120U R500	Screw M10x140 - cl.5.8 + Washer M10	1	1
PS 140U R500	Screw M10x160 - cl.5.8 + Washer M10	1	1
PS 160U R500	Screw M10x180 - cl.5.8 + Washer M10	1	1
PSW 70 R500	Screw M10x90 - cl.5.8 + Washer M10	4	4
PSW 90 R500	Screw M10x110 - cl.5.8 + Washer M10	4	4
PSS 100 R500	Screw M10x120 - cl.5.8 + Washer M10	2	2
PSS 120 R500	Screw M10x140 - cl.5.8 + Washer M10	2	2
PSS 140 R500	Screw M10x160 - cl.5.8 + Washer M10	2	2
PSS 160 R500	Screw M10x180 - cl.5.8 + Washer M10	2	2
PSRU 60-200 R500	Screw M10x110 - cl.5.8 + Washer M10	4	4
PMFU 100	Screw M10x120 - cl.5.8 + Washer M10	1	1
PMFU 120	Screw M10x140 - cl.5.8 + Washer M10	1	1
PMFU 140	Screw M10x160 - cl.5.8 + Washer M10	1	1
PMFU 160	Screw M10x180 - cl.5.8 + Washer M10	1	1

<b>THREE-DIMENSIONAL NAILING PLATES</b>	<b>ANNEX 6</b> ETA 20/1044
<b>REFERENCE DOCUMENTS</b>	

- [1] European Assessment Document 130186-00-0603, edition July 2018,  
Three-dimensional nailing plates
- [2] EN 10346 Continuously hot-dip coated steel flat products - Technical delivery conditions
- [3] EN 10131 Cold rolled uncoated and zinc or zinc-nickel electrolytically coated low carbon and high yield strength steel flat products for cold forming - Tolerances on dimensions and shape
- [4] EN 10025-2 Hot rolled products of structural steels - Part 2: Technical delivery conditions for non-alloy structural steels
- [5] EN 14592+A1 Timber structures - Dowel-type fasteners – Requirements
- [6] EN 1995-1-1 Eurocode 5: Design of timber structures - Part 1-1: General - Common rules and rules for buildings
- [7] EN ISO 12944-2 Paints and varnishes - Corrosion protection of steel structures by protective paint systems - Part 2: Classification of environments
- [8] EN ISO 8970 Timber structures - Testing of joints made with mechanical fasteners - Requirements for wood density
- [9] EN 26891 Timber structures – Joints made with mechanical fasteners – General principles for the determination of strength and deformation characteristics
- [10] EN 384+A1 Structural timber – Determination of characteristic values of mechanical properties and density
- [11] EN 13183-2 Moisture content of a piece of sawn timber - Part 2: Estimation by electrical resistance method
- [12] EN 1309-1 Round and sawn timber - Method of measurement of dimensions - Part 1: Sawn timber
- [13] EN 14358 Timber structures – Calculation and verification of characteristic values
- [14] EN 13501-1 Fire classification of construction products and building elements - Part 1: Classification using test data from reaction to fire tests